



GS1 XML-Dokumentation

Nachrichtentyp: Notification of Delivery

Version: 1.0

Datum: 08.02.2008

Copyright Deutsche Bundesbank

Inhalt

1.	Introduction.....	3
2.	Guideline Details	6
3.	Implementation Consideration	14
4.	GS1 XML Schemas	15
5.	Bundesbank XML-Schemas	81
6.	Instance File	88

1. Introduction

Problem Statement

Generally, the Despatch Advice enables one Shipper to provide information about the content of a shipment to one Receiver. Specifically, the Despatch Advice serves as a link to a prior agreement between Shipper and Receiver and is applicable to one or many Receiver destination points from one Shipper launch point. Furthermore, the Despatch Advice may be used to indicate the despatch of goods being returned by the Receiver. The Despatch Advice may be utilized downstream between retailers, suppliers, 3PLs, carriers and manufacturers as well as upstream between manufacturers, 3PLs and material suppliers.

Objective

The objective of the Despatch Advice is:

- To facilitate the receipt of goods
- To make the despatch advice applicable to a replenishment scenario where there is no link to an order but to a contract or other kind of agreement.
- To make the despatch advice applicable to multiple destination points
- To provide more detailed information about the shipment as well as the content of a shipment from a shipper and if applicable the shipper's warehouse to the receiver and his warehouse
- To make the despatch advice applicable for the despatch of goods being returned

Audience

Retailers, manufacturers, warehouses, material suppliers, carriers and any other third party such as a logistic service or 3PL provider involved in the despatch and receipt of goods.

Business Context

Industry: All
Geopolitical: Global
Product: All
Process: Deliver
System Capabilities: EAN.UCC
Official Constraints: None

Business Transaction View

The Despatch Advice must contain certain information, in line item format, to convey comparative information to the Receiver. The Despatch Advice therefore will provide for the identification of the individual lines within the Despatch Advice by line sequence number. The Despatch Advice may provide for a reference to other related documents, such as the Order, Delivery Note and Consignment. The Despatch Advice may also include a reference to a contract and may include the line sequence numbers from the documents Order, Delivery Note, Consignment and Contract.

Business Transaction Use Case Diagram



Use Case Description

Use Case Name:	Generate Despatch Advice
Use Case Description:	Describes a complete process whereby a Shipper generates a Despatch Advice based on information about the order and the product.
Actors:	Receiver and Shipper
Preconditions:	Master data alignment of locations (GLNs) and products (GTINs).
Postconditions:	Check of the received physical goods with the information of the Despatch Advice and the check of the state of the goods themselves.
General Scenario:	<ol style="list-style-type: none"> 1. Shipper issues the Despatch Advice containing the information of the actual physical shipment. 2. Receiver receives Despatch Advice. 3. If necessary, Receiver creates and sends Despatch Advice to Shipper indicating returned goods. *See role reversal note in activity and sequence diagrams.

Business Transaction Activity Diagram(s)

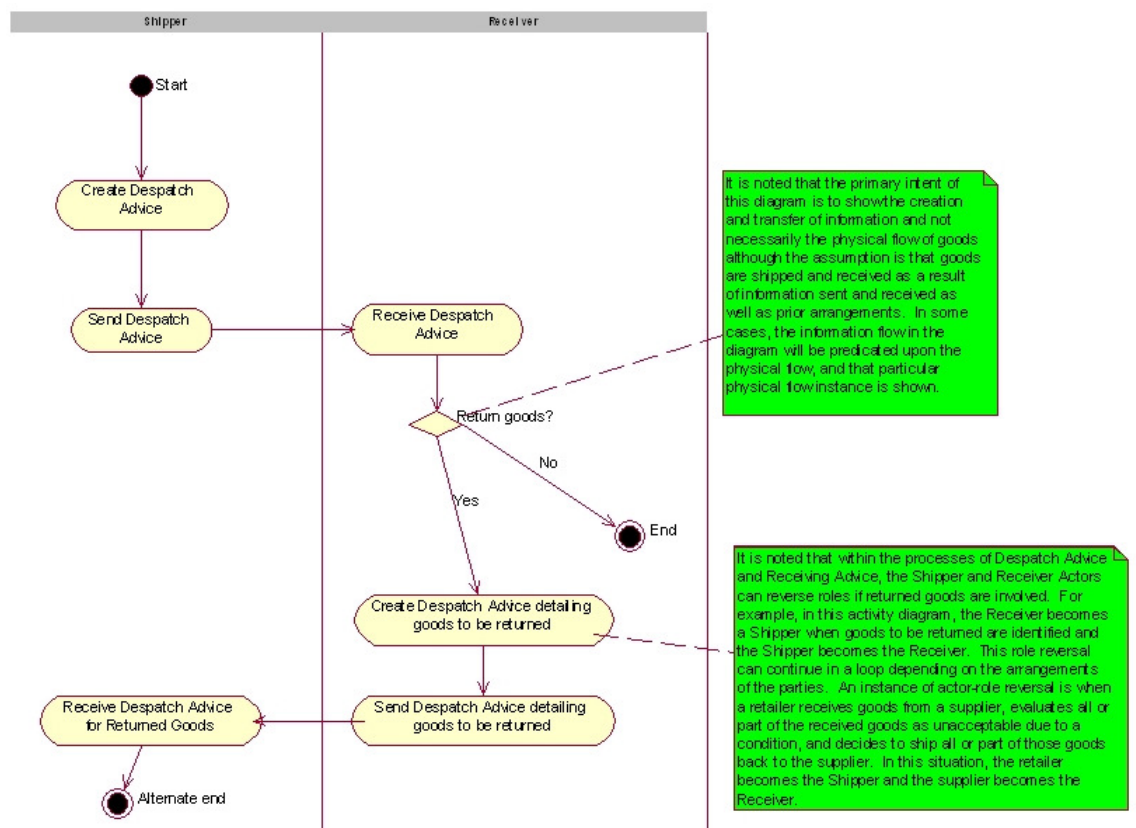

Business Transaction

Sequence Diagram(s)

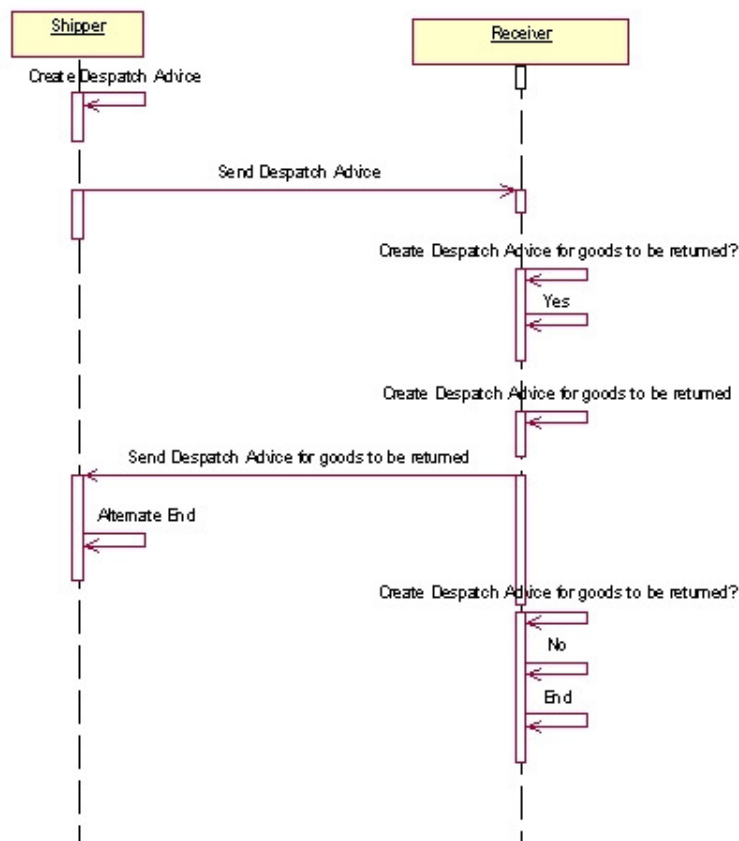

It is noted that the primary intent of this diagram is to show the creation and transfer of information and not necessarily the physical flow of goods although the assumption is that goods are shipped and received as a result of information sent and received as well as prior arrangements. In some cases, the information flow in the diagram will be predicated upon the physical flow, and that particular physical flow instance is shown.

It is noted that within the processes of Despatch Advice and Receiving Advice, the Shipper and Receiver Actors can reverse roles if returned goods are involved. For example, in this activity diagram, the Receiver becomes a Shipper when goods to be returned are identified and the Shipper becomes the Receiver. This role reversal can continue in a loop depending on the arrangements of the parties.

2. Guideline Details

		deliver:despatchAdvice	
			Element
			Type: deliver:DespatchAdviceType
			Business T.: Notification of delivery
M	required	creationDateTime	Type: xsd:dateTime
			Business T. Creation date
			Example: <creationDateTime>2007-10-26T21:32:52</creationDateTime>
M	required	documentStatus	Type: eanucc:DocumentStatusListType
M	1..1	xsd:sequence	ContentModel
O	0..1	contentVersion	Element
			Type: eanucc:VersionType
M	1..1	xsd:sequence	ContentModel
M	1..1	versionIdentification	Element
			Type: xsd:string
M	1..1	xsd:sequence	ContentModel
M	1..1	despatchAdviceIdentification	Element
			Type: eanucc:EntityIdentificationType
M	1..1	xsd:sequence	ContentModel
M	1..1	uniqueCreatorIdentification	Element
			Type: restriction (xsd:string)
			Length: 1 .. 80
			Business T. Document number
M	1..1	contentOwner	Element
			Type: eanucc:PartyIdentificationType
M	1..1	xsd:sequence	ContentModel
M	1..1	gln	Element
			Type: eanucc:GlobalLocationNumberType
			Pattern: \d{13}
			Business T. Message sender
M	1..1	shipTo	Element
			Type: eanucc:PartyIdentificationType
M	1..1	xsd:sequence	ContentModel

M	1..1	gln	Element Type: eanucc:GlobalLocationNumberType Pattern: \d{13} Business T. Payer
O	0..unbounded	additionalPartyIdentification	Element Type: eanucc:AdditionalPartyIdentificationType
M	1..1	xsd:sequence	ContentModel
M	1..1	additionalPartyIdentificationValue	Element Type: xsd:string Business T. IBAN number
M	1..1	additionalPartyIdentificationType	Element Type: eanucc:AdditionalPartyIdentificationListType Business T. FOR_INTERNAL_USE_1 = IBAN number Code/Description FOR_INTERNAL_USE_1
M	1..1	receiver	Element Type: eanucc:PartyIdentificationType
M	1..1	xsd:sequence	ContentModel
M	1..1	gln	Element Type: eanucc:GlobalLocationNumberType Pattern: \d{13} Business T. Message receiver
O	0..1	pickUpLocation	Element Type: eanucc:PartyIdentificationType
M	1..1	xsd:sequence	ContentModel
M	1..1	gln	Element Type: eanucc:GlobalLocationNumberType Pattern: \d{13} Business T. GLN of cashcenter/branch (pick-up place)
M	1..1	shipper	Element Type: eanucc:PartyIdentificationType
M	1..1	xsd:sequence	ContentModel
M	1..1	gln	Element Type: eanucc:GlobalLocationNumberType Pattern: \d{13} Business T. Carrier from order

O	0..1	purchaseOrder	Element	Type: eanucc:DocumentReferenceType
M	1..1	xsd:sequence	ContentModel	
M	1..1	uniqueCreatorIdentification	Element	Type: restriction (xsd:string)
			Length: 1 .. 80	Business T. Order number
M	1..1	contentOwner	Element	Type: eanucc:PartyIdentificationType
M	1..1	xsd:sequence	ContentModel	
M	1..1	gln	Element	Type: eanucc:GlobalLocationNumberType
			Pattern: \d{13}	Business T. Message receiver
O	0..1	purchaseConditions	Element	Type: eanucc:DocumentReferenceType
M	1..1	xsd:sequence	ContentModel	
M	1..1	uniqueCreatorIdentification	Element	Type: restriction (xsd:string)
			Length: 1 .. 80	Business T. Reason for payment (max 140 characters)
M	1..1	contentOwner	Element	Type: eanucc:PartyIdentificationType
M	1..1	xsd:sequence	ContentModel	
M	1..1	gln	Element	Type: eanucc:GlobalLocationNumberType
			Pattern: \d{13}	Business T. (Message sender from order)
O	0..1	consignmentInformation	Element	Type: deliver:ConsignmentInformationType
M	1..1	xsd:sequence	ContentModel	
O	0..1	consignmentIdentification	Element	Type: eanucc:ReferenceType

M	1..1	xsd:sequence	ContentModel
M	1..1	referenceDateTime	Element Type: xsd:dateTime Business T. Notification of delivery date Example: <referenceDateTime>2007-10-26T21:32:52</referenceDateTime>
M	1..1	referenceIdentification	Element Type: restriction (xsd:string) Length: 1 .. 80 Business T. Number of despatch unit (SSCC) Master
M	1..1	packageInformation	Element Type: deliver:PackageInformationType
M	1..1	xsd:sequence	ContentModel
M	1..1	numberOfUnits	Element Type: xsd:integer FractionDigits: 0 Business T. Number of visible packages TotalDigits:
O	0..unbounded	unitMeasurement	Element Type: eanucc:UnitMeasurementType
M	1..1	xsd:sequence	ContentModel
M	1..1	measurementType	Element Type: eanucc:MeasurementTypeCodeListType Business T. NET_VOLUME = Amount withdrawal in euro with decimals Code/Description NET_VOLUME
M	1..1	measurementValue	Element Type: eanucc:MeasurementValueType
M	required	unitOfMeasure	Element Type: restriction (xsd:string) Length: 0 .. 3 Business T. Fixed value "EUR"
M	1..1	xsd:sequence	ContentModel
M	1..1	value	Element Type: restriction (xsd:decimal) FractionDigits: TotalDigits: 15

M	1..1	despatchInformation	Business T. Amount withdrawal in euro with decimals <i>Element</i> Type: deliver:DespatchInformationType
M	1..1	xsd:sequence	<i>ContentModel</i>
M	1..1	xsd:choice	<i>ContentModel</i>
M	1..1	estimatedDelivery	<i>Element</i> Type: deliver:EstimatedDeliveryType
M	1..1	xsd:sequence	<i>ContentModel</i>
M	1..1	xsd:choice	<i>ContentModel</i>
M	1..1	estimatedDeliveryDateTime	<i>Element</i> Type: xsd:dateTime Business T. Provision date, requested Example: <estimatedDeliveryDateTime>2007-10-26T21:32:52</estimatedDeliveryDateTime>
M	1..1	xsd:choice	<i>ContentModel</i>
M	1..unbounded	despatchAdviceLogisticUnitLineItem	<i>Element</i> Type: deliver:DespatchAdviceLogisticUnitLineItemTyp
M	1..1	xsd:sequence	<i>ContentModel</i>
M	1..1	logisticUnitIdentification	<i>Element</i> Type: eanucc:LogisticUnitIdentificationType
M	1..1	xsd:sequence	<i>ContentModel</i>
M	1..1	serialShipmentContainerCode	<i>Element</i> Type: eanucc:SSCCType
M	1..1	xsd:sequence	<i>ContentModel</i>
M	1..1	serialShippingContainerCode	<i>Element</i> Type: restriction (xsd:string) Pattern: \d{18}
O	0..unbounded	additionalLogisticUnitIdentification	Business T. Number of despatch unit (SSCC) <i>Element</i> Type: eanucc:AdditionalLogisticUnitIdentificationType
M	1..1	xsd:sequence	<i>ContentModel</i>
M	1..1	logisticUnitIdentification	<i>Element</i> Type: xsd:string

O	0..1	quantityOfChildren	Business T. Number of portion given in order Element Type: xsd:integer FractionDigits: 0 TotalDigits:
O	0..1	packageType	Business T. Number of packages Element Type: deliver:PackageTypeDescriptionCodeType
M	1..1	xsd:sequence	ContentModel
M	1..1	packageTypeDescriptionCodeValue	Element Type: restriction (xsd:string) Length: 1 .. 3 Business T. Packaging details (Values: NE=Open; BG=Safebag; BX=P-Box; PB=P-Container; 201=Palett1/1; CG=Skeleton trolley; ID=M-Box)
O	0..1	levelId	Element Type: deliver:LevelIdentificationType
M	1..1	xsd:sequence	ContentModel
M	1..1	levelIdentification	Element Type: xsd:integer FractionDigits: 0 TotalDigits:
O	0..1	parentLevelId	Business T. Sequence of the packages (despatch units / articles) Element Type: deliver:LevelIdentificationType
M	1..1	xsd:sequence	ContentModel
M	1..1	levelIdentification	Element Type: xsd:integer FractionDigits: 0 TotalDigits:
M	1..1	xsd:sequence	Business T. Hierarchy level ContentModel
O	0..unbounded	despatchAdviceItemContainmentLineItem	Element Type: deliver:DespatchAdviceItemContainmentLineItem
M	required	number	Type: restriction (xsd:nonNegativeInteger) FractionDigits: 0 Inclusive: 0 .. TotalDigits: 6 Business T. Line item number

M	1..1	xsd:sequence	ContentModel
M	1..1	containedItemIdentification	Element Type: eanucc:TradeItemIdentificationType
M	1..1	xsd:sequence	ContentModel
M	1..1	gtin	Element Type: eanucc:GlobalTradeItemNumberType Pattern: \d{14} Business T. GTIN Article identification
O	0..unbounded	additionalTradeItemIdentification	Element Type: eanucc:AdditionalTradeItemIdentificationType
M	1..1	xsd:sequence	ContentModel
M	1..1	additionalTradeItemIdentificationValue	Element Type: restriction (xsd:string) Length: 1 .. 80 Business T. Tour
M	1..1	additionalTradeItemIdentificationType	Element Type: eanucc:AdditionalTradeItemIdentificationListType Business T. FOR_INTERNAL_USE_3 = Tour Code/Description FOR_INTERNAL_USE_3
O	0..1	customer	Element Type: eanucc:DetailLevelReferenceType
M	required	number	Element Type: restriction (xsd:nonNegativeInteger) FractionDigits: 0 TotalDigits: 6 Inclusive: 0 .. Business T. Fixed value: "1"
M	1..1	xsd:sequence	ContentModel
M	1..1	reference	Element Type: eanucc:ReferenceType
M	1..1	xsd:sequence	ContentModel
M	1..1	referenceDateTime	Element Type: xsd:dateTime Business T. Provision date, requested

M	1..1	referenceIdentification	<i>Element</i> Type: restriction (xsd:string) Length: 1 .. 80 Example: <referenceDateTime>2007-10-26T21:32:52</referenceDateTime> Business T. Location of delivery (GLN), receiver of portion
M	1..1	xsd:sequence	<i>ContentModel</i>
M	1..1	quantityContained	<i>Element</i> Type: eanucc:QuantityType
M	1..1	xsd:sequence	<i>ContentModel</i>
M	1..1	value	<i>Element</i> Type: xsd:float Business T. Ordered quantity

3. Implementation Consideration

The implementer of these standards needs to be aware of the interrelationship amongst the XML Schemas and the importance of using only interoperable versions.

Schemas

common

AdditionalLogisticUnitIdentification.xsd, version 2.1.1
AdditionalPartyIdentificationList.xsd, version 2.1.1
AdditionalTradeItemIdentificationList.xsd, version 2.1.1
Command.xsd, version 2.1.1
Country.xsd, version 2.1.1
DateTimePeriod.xsd, version 2.1.1
Document.xsd, version 2.1.1
DocumentCommand.xsd, version 2.1.1
DocumentCommandList.xsd, version 2.1.1
DocumentLineReference.xsd, version 2.1.1
DocumentOrDocumentLineReference.xsd, version 2.1.1
DocumentReference.xsd, version 2.1.1
DocumentStatusList.xsd, version 2.1.1
EntityIdentification.xsd, version 2.1.1
Extension.xsd, version 2.1.1
LogisticUnitIdentification.xsd, version 2.1.1
Measurement.xsd, version 2.1.1
MeasurementTypeCodeList.xsd, version 2.1.1
MeasurementUnitCode.xsd, version 2.1.1
Message.xsd, version 2.1.1
PartyIdentification.xsd, version 2.1.1
Quantity.xsd, version 2.1.1
ResponseStatusList.xsd, version 2.1.1
SSCC.xsd, version 2.1.1
TimeOrDateTimePeriod.xsd, version 2.1.1
TimePeriod.xsd, version 2.1.1 TradeItemIdentification.xsd, version 2.1.1
Transaction.xsd, version 2.1.1
TransactionalItemData.xsd, version 2.1.1
TransportationMethodTypeCodeList.xsd, version 2.1.1
UnitMeasurement.xsd, version 2.1.1
Transaction.xsd, version 2.0.2

deliver

ChangeReasonCodeList.xsd, version 2.1.1
DespatchAdvice.xsd, version 2.1.1
IncotermCodeList.xsd, version 2.1.1
LogisticUnitMeasurement.xsd, version 2.1.1
LogisticUnits.xsd, version 2.1.1
PackageDimension.xsd, version 2.1.1
PackageTypeDescriptionCode.xsd, version 2.1.1
TradeItemUnit.xsd, version 2.1.1

csh

DocumentIdentification.xsd
Partner.xsd
StandardBusinessDocumentHeader.xsd

proxy

DespatchAdviceProxy.xsd

4. GS1 XML Schemas

Schema **DespatchAdvice.xsd**

element **despatchAdvice**

diagram

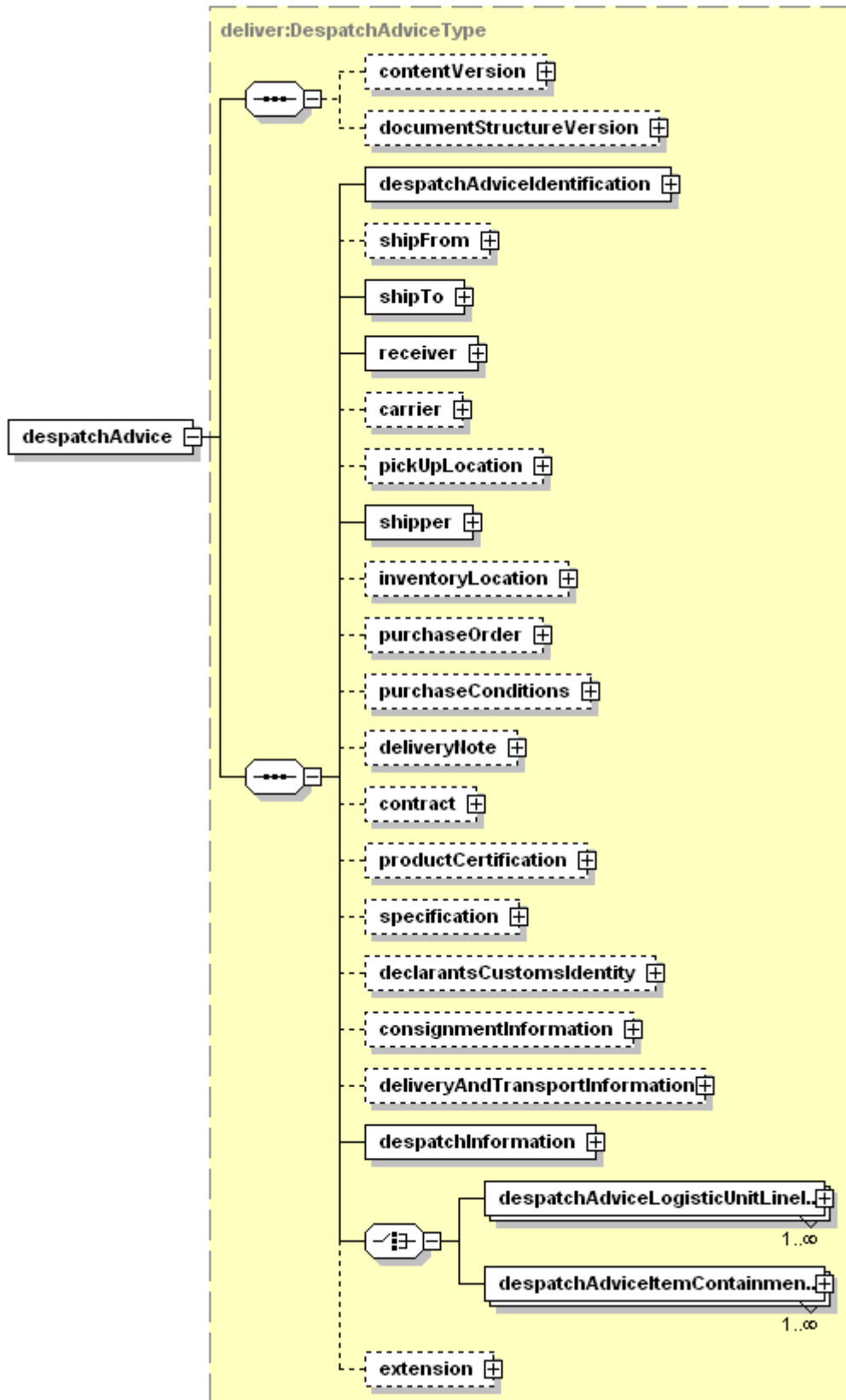

namespace urn:ean.ucc:deliver:2

type [deliver:DespatchAdviceType](#)

children [contentVersion](#) [documentStructureVersion](#) [despatchAdviceIdentification](#) [shipFrom](#) [shipTo](#) [receiver](#) [carrier](#) [pickUpLocation](#) [shipper](#) [inventoryLocation](#) [purchaseOrder](#) [purchaseConditions](#) [deliveryNote](#) [contract](#) [productCertification](#) [specification](#) [declarantsCustomsIdentity](#) [consignmentInformation](#) [deliveryAndTransportInformation](#) [despatchInformation](#) [despatchAdviceLogisticUnitLineItem](#) [despatchAdviceItemContainmentLineItem](#) [extension](#)

attributes	Name	Type	Use	Default	Fixed	Annotation
	lastUpdateDate	xsd:date				
	creationDateTim	xsd:dateTime	required			
	e					
	documentStatus	eanucc:Docume ntStatusListType	required			

source `<xsd:element name="despatchAdvice" type="deliver:DespatchAdviceType" substitutionGroup="eanucc:document"/>`

complexType **ActualShippingType**

diagram

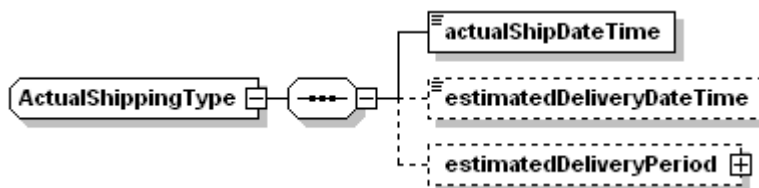

namespace urn:ean.ucc:deliver:2

children [actualShipDateTime](#) [estimatedDeliveryDateTime](#) [estimatedDeliveryPeriod](#)

used by element [DespatchInformationType/actualShipping](#)

source `<xsd:complexType name="ActualShippingType">
<xsd:sequence>
<xsd:element name="actualShipDateTime" type="xsd:dateTime"/>
<xsd:element name="estimatedDeliveryDateTime" type="xsd:dateTime" minOccurs="0"/>
<xsd:element name="estimatedDeliveryPeriod" type="eanucc:TimeOrDateTimePeriodType" minOccurs="0"/>
</xsd:sequence>
</xsd:complexType>`

element **ActualShippingType/actualShipDateTime**

diagram



type `xsd:dateTime`

source `<xsd:element name="actualShipDateTime" type="xsd:dateTime"/>`

element **ActualShippingType/estimatedDeliveryDateTime**

diagram



type `xsd:dateTime`

source `<xsd:element name="estimatedDeliveryDateTime" type="xsd:dateTime" minOccurs="0"/>`

element **ActualShippingType/estimatedDeliveryPeriod**

diagram

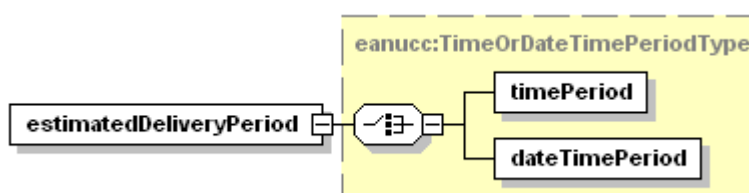

type [eanucc:TimeOrDateTimePeriodType](#)
 children [timePeriod](#) [dateTimePeriod](#)
 source `<xsd:element name="estimatedDeliveryPeriod" type="eanucc:TimeOrDateTimePeriodType" minOccurs="0"/>`

complexType **ConsignedItemWeightType**

diagram

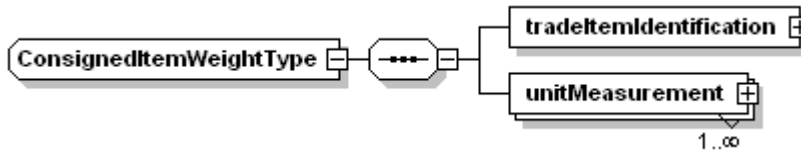

namespace urn:ean.ucc:deliver:2

children [tradeltemIdentification](#) [unitMeasurement](#)

used by element [ConsignmentInformationType/consignedItemWeight](#)

source `<xsd:complexType name="ConsignedItemWeightType">
 <xsd:sequence>
 <xsd:element name="tradeltemIdentification" type="eanucc:TradeltemIdentificationType"/>
 <xsd:element name="unitMeasurement" type="eanucc:UnitMeasurementType" maxOccurs="unbounded"/>
 </xsd:sequence>
 </xsd:complexType>`

element **ConsignedItemWeightType/tradeltemIdentification**

diagram

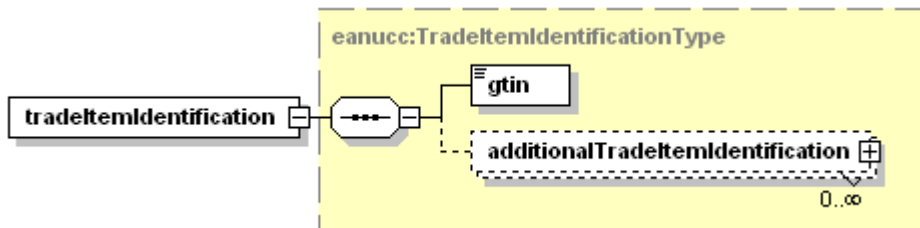

type [eanucc:TradeltemIdentificationType](#)

children [gtin](#) [additionalTradeltemIdentification](#)

source `<xsd:element name="tradeltemIdentification" type="eanucc:TradeltemIdentificationType"/>`

element **ConsignedItemWeightType/unitMeasurement**

diagram

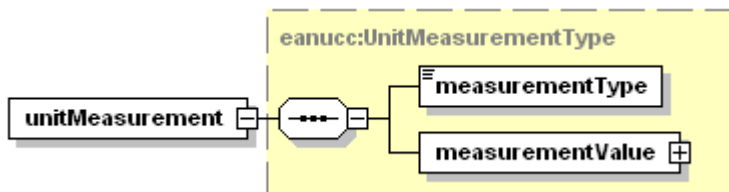

type [eanucc:UnitMeasurementType](#)

children [measurementType](#) [measurementValue](#)

source `<xsd:element name="unitMeasurement" type="eanucc:UnitMeasurementType" maxOccurs="unbounded"/>`

complexType **ConsignmentInformationType**

diagram

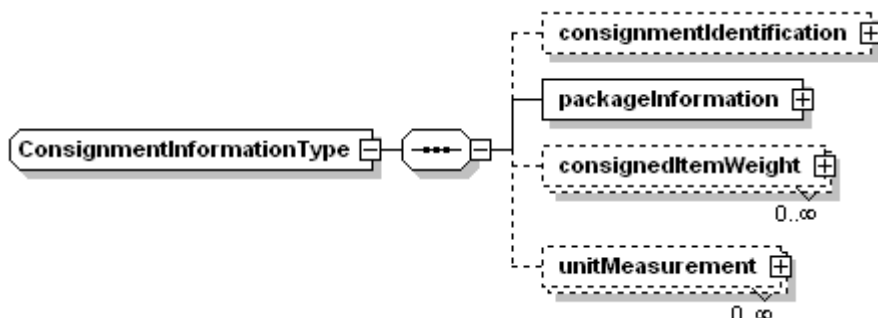

namespace urn:ean.ucc:deliver:2

children [consignmentIdentification](#) [packageInformation](#) [consignedItemWeight](#) [unitMeasurement](#)

used by element [DespatchAdviceType/consignmentInformation](#)

```
<xsd:complexType name="ConsignmentInformationType">
  <xsd:sequence>
    <xsd:element name="consignmentIdentification" type="eanucc:ReferenceType" minOccurs="0"/>
    <xsd:element name="packageInformation" type="deliver:PackageInformationType"/>
    <xsd:element name="consignedItemWeight" type="deliver:ConsignedItemWeightType" minOccurs="0"
      maxOccurs="unbounded"/>
    <xsd:element name="unitMeasurement" type="eanucc:UnitMeasurementType" minOccurs="0"
      maxOccurs="unbounded"/>
  </xsd:sequence>
</xsd:complexType>
```

element **ConsignmentInformationType/consignmentIdentification**

diagram

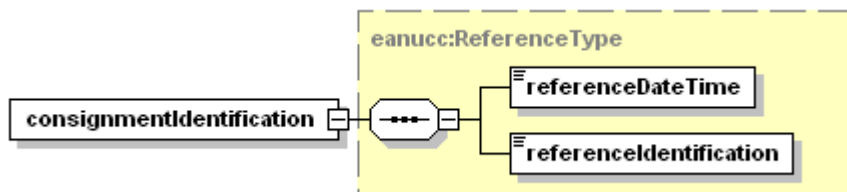

type [eanucc:ReferenceType](#)

children [referenceDateTime](#) [referenceIdentification](#)

source `<xsd:element name="consignmentIdentification" type="eanucc:ReferenceType" minOccurs="0"/>`

element **ConsignmentInformationType/packageInformation**

diagram

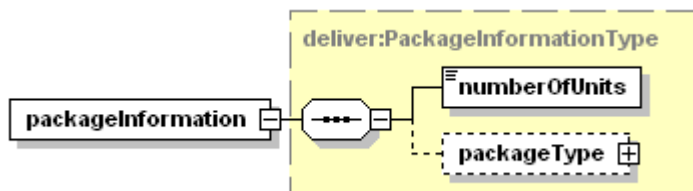

type [deliver:PackageInformationType](#)

children [numberOfUnits](#) [packageType](#)

source `<xsd:element name="packageInformation" type="deliver:PackageInformationType"/>`

element **ConsignmentInformationType/consignedItemWeight**

diagram

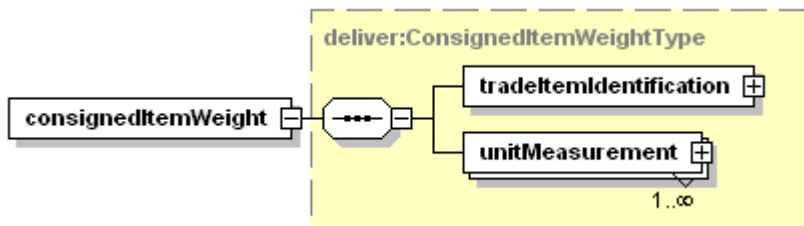

type [deliver:ConsignedItemWeightType](#)

children [tradeItemIdentification](#) [unitMeasurement](#)

source `<xsd:element name="consignedItemWeight" type="deliver:ConsignedItemWeightType" minOccurs="0" maxOccurs="unbounded"/>`

element **ConsignmentInformationType/unitMeasurement**

diagram

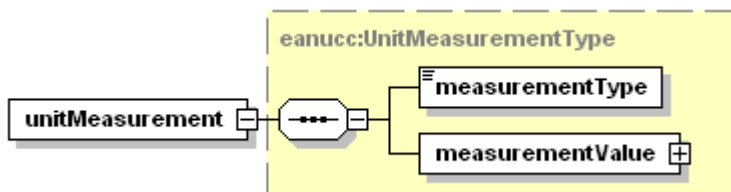

type [eanucc:UnitMeasurementType](#)

children [measurementType](#) [measurementValue](#)

source `<xsd:element name="unitMeasurement" type="eanucc:UnitMeasurementType" minOccurs="0" maxOccurs="unbounded"/>`

complexType **DeliveryAndTransportInformationType**

diagram

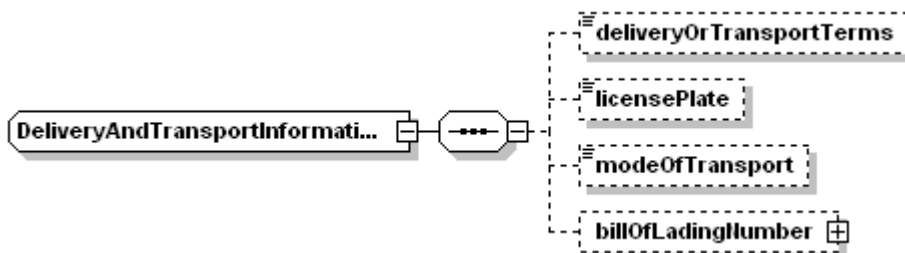

namespace urn:ean.ucc:deliver:2

children [deliveryOrTransportTerms](#) [licensePlate](#) [modeOfTransport](#) [billOfLadingNumber](#)

used by element [DespatchAdviceType/deliveryAndTransportInformation](#)

source `<xsd:complexType name="DeliveryAndTransportInformationType">
<xsd:sequence>
<xsd:element name="deliveryOrTransportTerms" type="deliver:IncotermCodeListType" minOccurs="0"/>
<xsd:element name="licensePlate" type="xsd:string" minOccurs="0"/>
<xsd:element name="modeOfTransport" type="eanucc:TransportationMethodTypeCodeListType" minOccurs="0"/>
<xsd:element name="billOfLadingNumber" type="eanucc:ReferenceType" minOccurs="0"/>
</xsd:sequence>
</xsd:complexType>`

element **DeliveryAndTransportInformationType/deliveryOrTransportTerms**

diagram

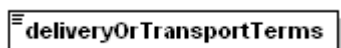

type [deliver:IncotermCodeListType](#)

facets

- enumeration CFR
- enumeration CIF
- enumeration CIP
- enumeration CPT
- enumeration DAF
- enumeration DDP
- enumeration DDU
- enumeration DES
- enumeration DEQ
- enumeration EXW
- enumeration FAS
- enumeration FCA
- enumeration FOB

source `<xsd:element name="deliveryOrTransportTerms" type="deliver:IncotermCodeListType" minOccurs="0"/>`

element **DeliveryAndTransportInformationType/licensePlate**



type **xsd:string**

source `<xsd:element name="licensePlate" type="xsd:string" minOccurs="0"/>`

element **DeliveryAndTransportInformationType/modeOfTransport**

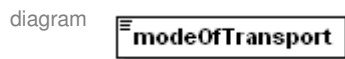

type [eanucc:TransportationMethodTypeCodeListType](#)

facets

- enumeration AIR
- enumeration AIR_CHARTER
- enumeration AIR_EXPRESS
- enumeration AIR_FREIGHT
- enumeration BEST_WAY_SHIPPERS_OPTION
- enumeration BOOK_POSTAL
- enumeration BUS
- enumeration CAB
- enumeration CONSOLIDATION
- enumeration CONTRACT_CARRIER
- enumeration CUSTOMER_PICKUP
- enumeration CUSTOMER_PICKUP_OR_CUSTOMERS_EXPENSE
- enumeration EXPEDITED_TRUCK
- enumeration GEOGRAPHIC_RECEIVING
- enumeration GEOGRAPHIC_RECEIVING_SHIPPING
- enumeration GEOGRAPHIC_SHIPPING
- enumeration INLAND_WATERWAY
- enumeration INTERMODAL_PIGGYBACK
- enumeration LESS_THAN_TRUCK_LOAD
- enumeration MOTOR
- enumeration MOTOR_COMMON_CARRIER
- enumeration MOTOR_FLATBED
- enumeration MOTOR_PACKAGE_CARRIER
- enumeration MOTOR_TRUCKLOAD
- enumeration MOTOR_VAN
- enumeration MUTUALLY_DEFINED
- enumeration OCEAN
- enumeration PARCEL_POST
- enumeration PIPELINE
- enumeration POOLED_AIR
- enumeration POOLED_PIGGYPACK
- enumeration POOL_TO_POOL
- enumeration POOLED_RAIL
- enumeration POOLED_TRUCK
- enumeration PRIVATE_CARRIER
- enumeration PRIVATE_PARCEL_SERVICE
- enumeration PRIVATE_VESSEL
- enumeration RAIL
- enumeration ROADTRAILER
- enumeration SEA_AIR
- enumeration STEAM_SHIP

enumeration SUPPLIER_TRUCK

source `<xsd:element name="modeOfTransport" type="eanucc:TransportationMethodTypeCodeListType" minOccurs="0"/>`

element **DeliveryAndTransportInformationType/billOfLadingNumber**

diagram

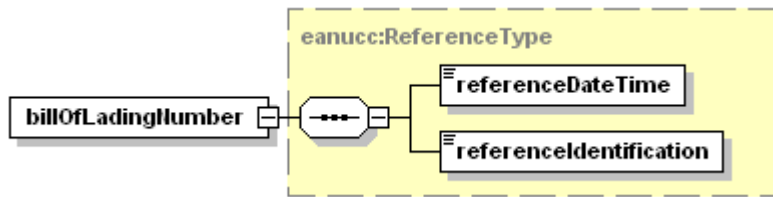

type [eanucc:ReferenceType](#)

children [referenceDateTime](#) [referenceIdentification](#)

source `<xsd:element name="billOfLadingNumber" type="eanucc:ReferenceType" minOccurs="0"/>`

complexType DespatchAdviceItemContainmentLineItemType

diagram

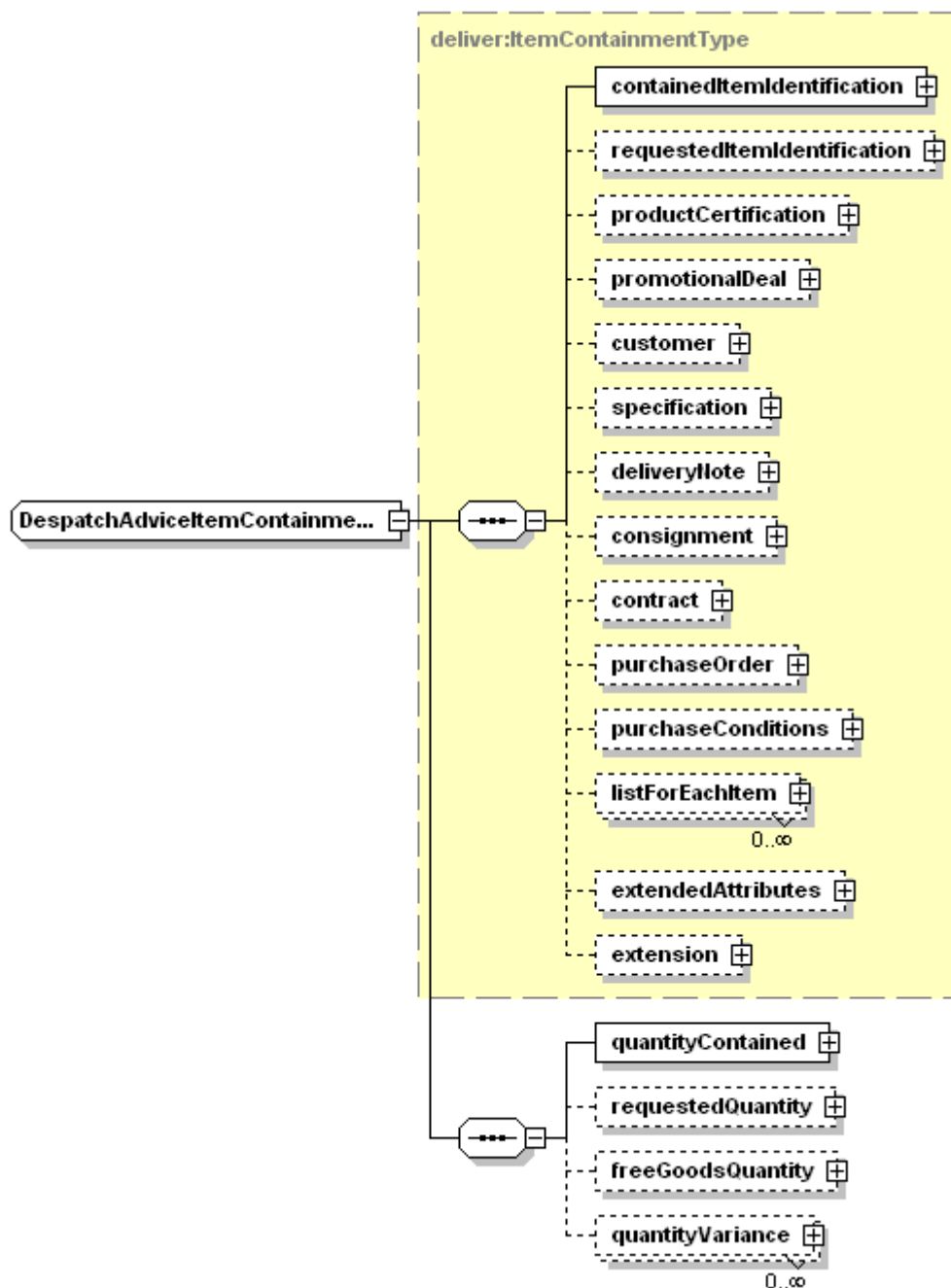

namespace urn:ean.ucc:deliver:2

type extension of [deliver:ItemContainmentType](#)

children [containedItemIdentification](#) [requestedItemIdentification](#) [productCertification](#) [promotionalDeal](#) [customer](#) [specification](#) [deliveryNote](#) [consignment](#) [contract](#) [purchaseOrder](#) [purchaseConditions](#) [listForEachItem](#) [extendedAttributes](#) [extension](#) [quantityContained](#) [requestedQuantity](#) [freeGoodsQuantity](#) [quantityVariance](#)

used by elements [DespatchAdviceLogisticUnitLineItemType/despatchAdviceItemContainmentLineItem](#) [DespatchAdviceType/despatchAdviceItemContainmentLineItem](#)

attributes	Name	Type	Use	Default	Fixed	Annotation
	number	xsd:nonNegative Integer	required			

```

source <xsd:complexType name="DespatchAdviceItemContainmentLineItemType">
  <xsd:complexContent>
    <xsd:extension base="deliver:ItemContainmentType">
      <xsd:sequence>
        <xsd:element name="quantityContained" type="eanucc:QuantityType"/>
      </xsd:sequence>
    </xsd:extension>
  </xsd:complexContent>
</xsd:complexType>
  
```

```

<xsd:element name="requestedQuantity" type="eanucc:QuantityType" minOccurs="0"/>
<xsd:element name="freeGoodsQuantity" type="eanucc:QuantityType" minOccurs="0"/>
<xsd:element name="quantityVariance" type="deliver:QuantityVarianceType" minOccurs="0"
maxOccurs="unbounded"/>
</xsd:sequence>
</xsd:extension>
</xsd:complexContent>
</xsd:complexType>

```

element **DespatchAdviceItemContainmentLineItemType/quantityContained**

diagram

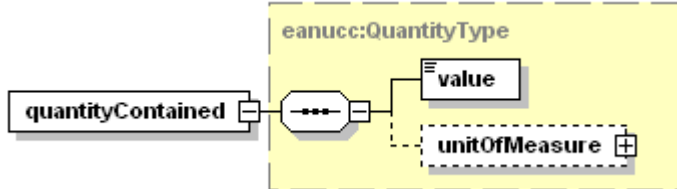

type [eanucc:QuantityType](#)

children [value](#) [unitOfMeasure](#)

source `<xsd:element name="quantityContained" type="eanucc:QuantityType"/>`

element **DespatchAdviceItemContainmentLineItemType/requestedQuantity**

diagram

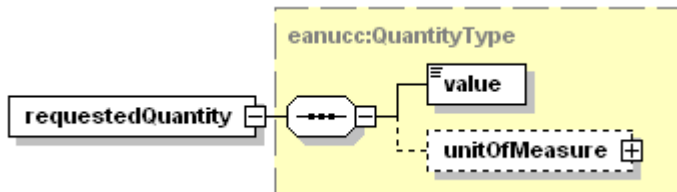

type [eanucc:QuantityType](#)

children [value](#) [unitOfMeasure](#)

source `<xsd:element name="requestedQuantity" type="eanucc:QuantityType" minOccurs="0"/>`

element **DespatchAdviceItemContainmentLineItemType/freeGoodsQuantity**

diagram

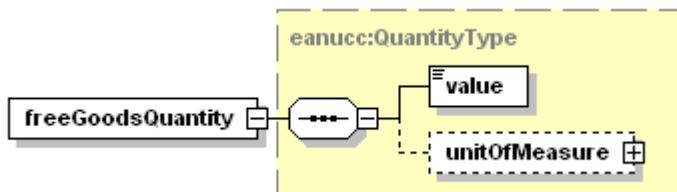

type [eanucc:QuantityType](#)

children [value](#) [unitOfMeasure](#)

source `<xsd:element name="freeGoodsQuantity" type="eanucc:QuantityType" minOccurs="0"/>`

element **DespatchAdviceItemContainmentLineItemType/quantityVariance**

diagram

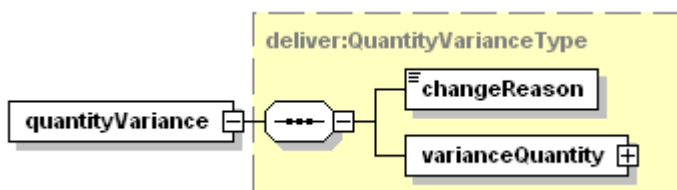

type [deliver:QuantityVarianceType](#)
 children [changeReason](#) [varianceQuantity](#)
 source `<xsd:element name="quantityVariance" type="deliver:QuantityVarianceType" minOccurs="0" maxOccurs="unbounded"/>`

complexType **DespatchAdviceLogisticUnitLinItem**

diagram

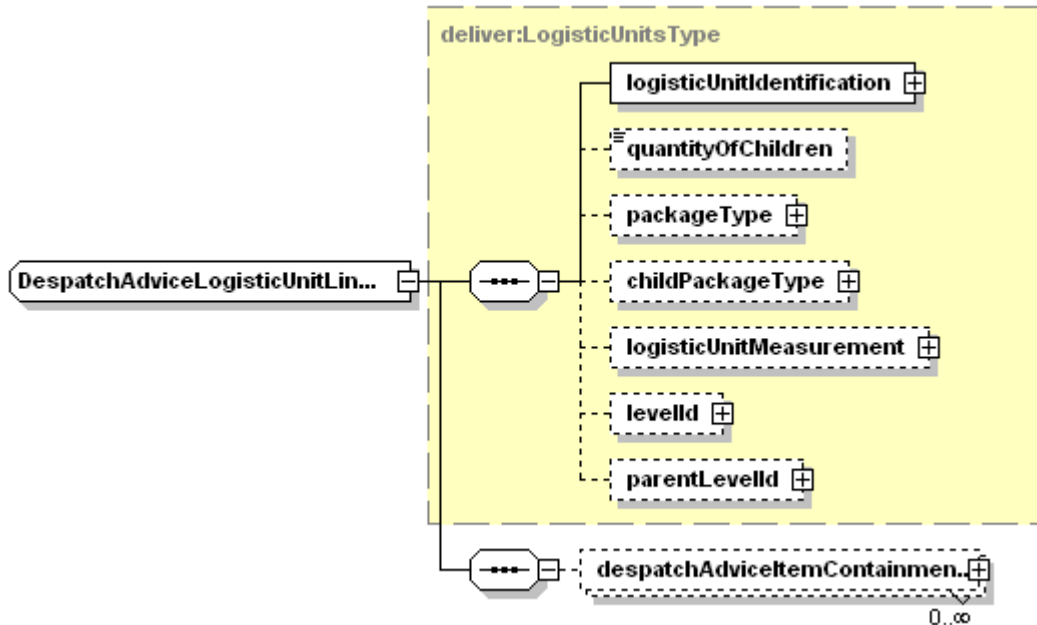

namespace urn:ean.ucc:deliver:2

type extension of [deliver:LogisticUnitsType](#)

children [logisticUnitIdentification](#) [quantityOfChildren](#) [packageType](#) [childPackageType](#) [logisticUnitMeasurement](#) [levelId](#) [parentLevelId](#) [despatchAdviceItemContainmentLinItem](#)

used by element [DespatchAdviceType/despatchAdviceLogisticUnitLinItem](#)

```

source <xsd:complexType name="DespatchAdviceLogisticUnitLinItemType">
  <xsd:complexContent>
    <xsd:extension base="deliver:LogisticUnitsType">
      <xsd:sequence>
        <xsd:element name="despatchAdviceItemContainmentLinItem"
          type="deliver:DespatchAdviceItemContainmentLinItem" minOccurs="0" maxOccurs="unbounded"/>
      </xsd:sequence>
    </xsd:extension>
  </xsd:complexContent>
</xsd:complexType>

```

element **DespatchAdviceLogisticUnitLineItem/DespatchAdviceItemContainmentLineItem**
 diagram

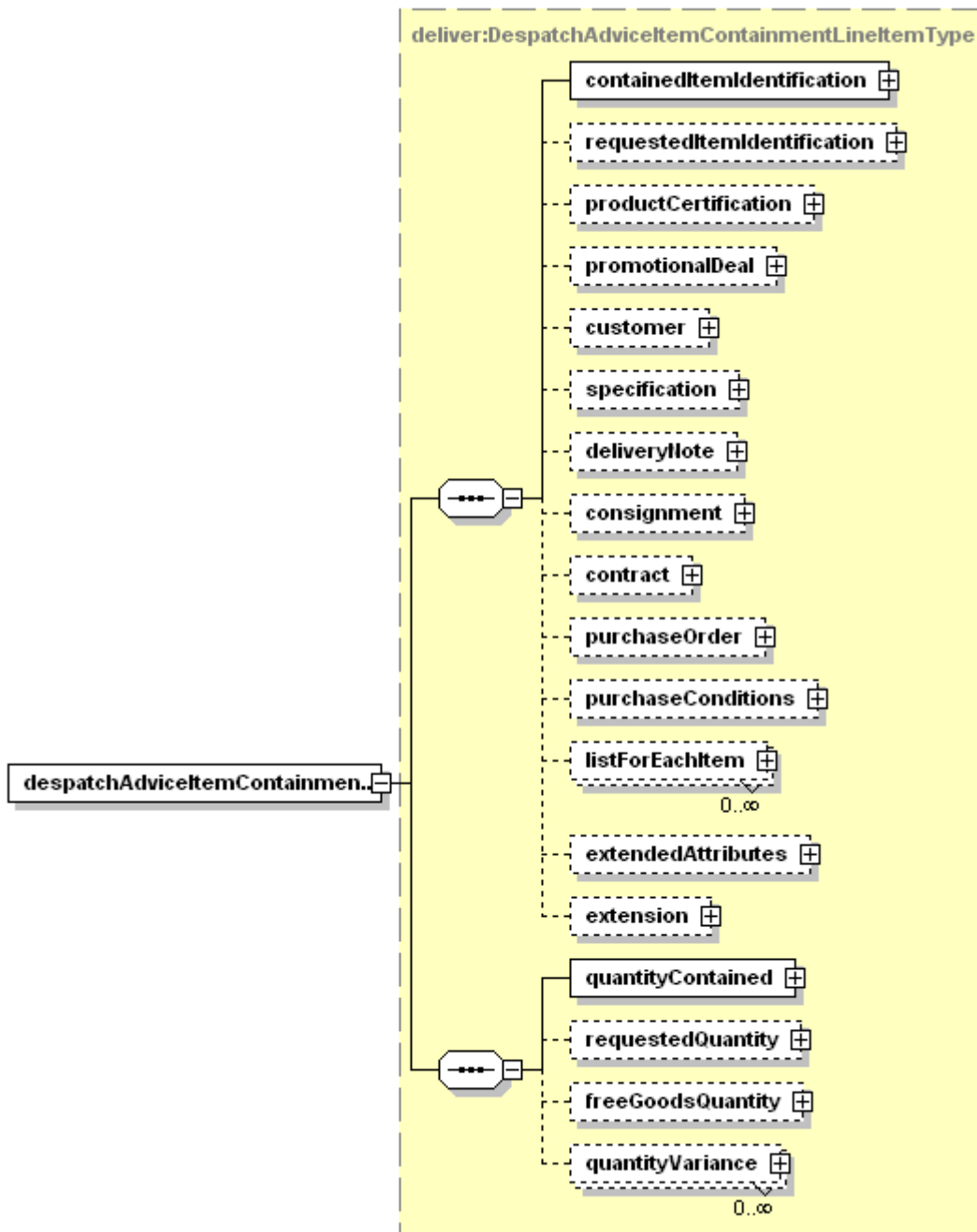

type [deliver:DespatchAdviceItemContainmentLineItemType](#)

children [containedItemIdentification](#) [requestedItemIdentification](#) [productCertification](#) [promotionalDeal](#) [customer](#) [specification](#) [deliveryNote](#) [consignment](#) [contract](#) [purchaseOrder](#) [purchaseConditions](#) [listForEachItem](#) [extendedAttributes](#) [extension](#) [quantityContained](#) [requestedQuantity](#) [freeGoodsQuantity](#) [quantityVariance](#)

attributes	Name	Type	Use	Default	Fixed	Annotation
	number	xsd:nonNegative Integer	required			

source `<xsd:element name="despatchAdviceItemContainmentLineItem" type="deliver:DespatchAdviceItemContainmentLineItemType" minOccurs="0" maxOccurs="unbounded"/>`

complexType **DespatchAdviceType**
 diagram

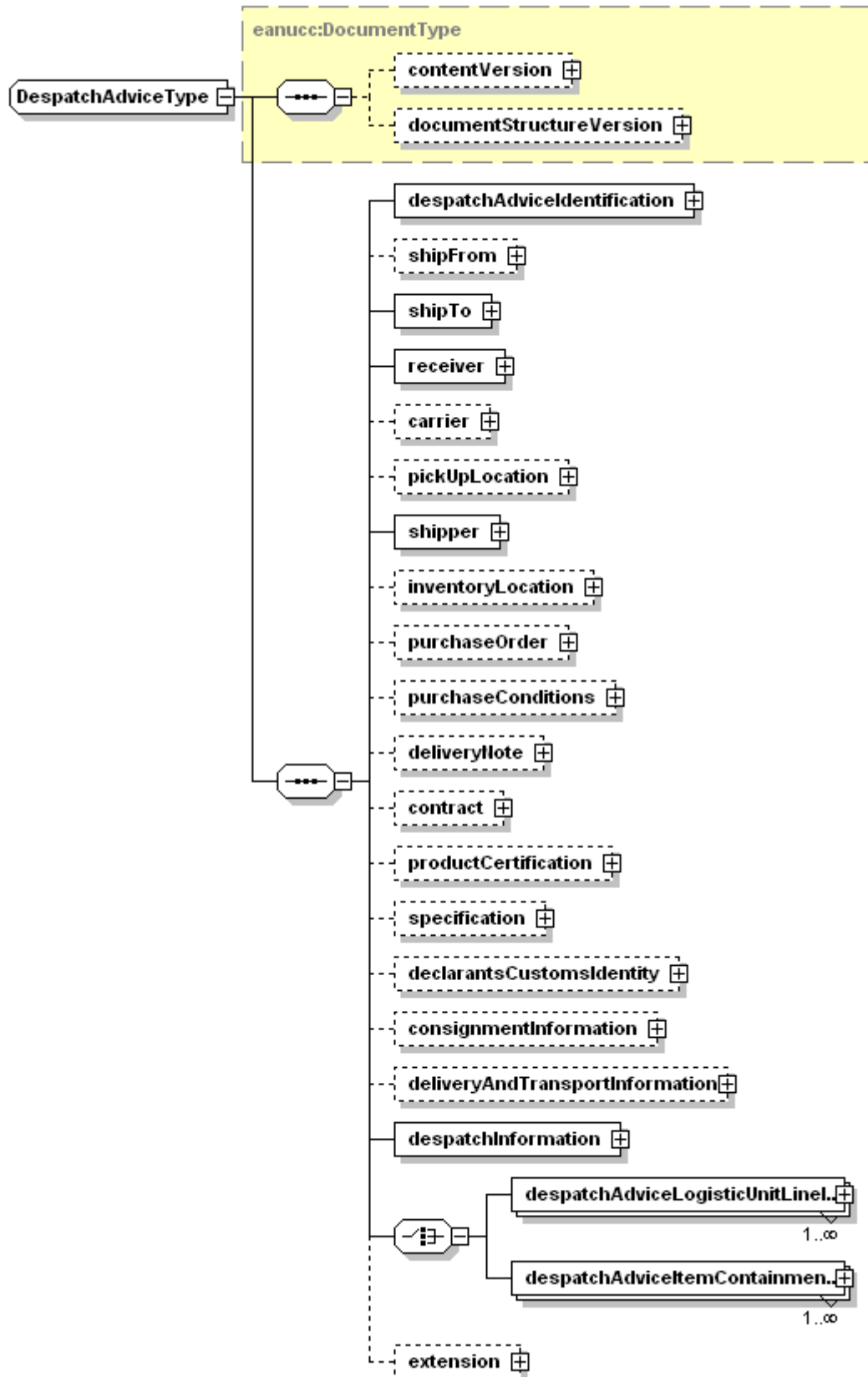

namespace urn:ean.ucc:deliver:2

type extension of [eanucc:DocumentType](#)

children [contentVersion](#) [documentStructureVersion](#) [despatchAdviceIdentification](#) [shipFrom](#) [shipTo](#) [receiver](#) [carrier](#) [pickUpLocation](#) [shipper](#) [inventoryLocation](#) [purchaseOrder](#) [purchaseConditions](#) [deliveryNote](#) [contract](#) [productCertification](#) [specification](#) [declarantsCustomsIdentity](#) [consignmentInformation](#) [deliveryAndTransportInformation](#) [despatchInformation](#) [despatchAdviceLogisticUnitLinItem](#) [despatchAdviceItemContainmentLinItem](#) [extension](#)

used by element [despatchAdvice](#)

attributes	Name	Type	Use	Default	Fixed	Annotation
	lastUpdateDate	xsd:date				
	creationDateTim	xsd:dateTime	required			
	documentStatus	eanucc:DocumentStatusListType	required			

```

source <xsd:complexType name="DespatchAdviceType">
  <xsd:complexContent>
    <xsd:extension base="eanucc:DocumentType">
      <xsd:sequence>
        <xsd:element name="despatchAdviceIdentification" type="eanucc:EntityIdentificationType"/>
        <xsd:element name="shipFrom" type="eanucc:PartyIdentificationType" minOccurs="0"/>
        <xsd:element name="shipTo" type="eanucc:PartyIdentificationType"/>
        <xsd:element name="receiver" type="eanucc:PartyIdentificationType"/>
        <xsd:element name="carrier" type="eanucc:PartyIdentificationType" minOccurs="0"/>
        <xsd:element name="pickUpLocation" type="eanucc:PartyIdentificationType" minOccurs="0"/>
        <xsd:element name="shipper" type="eanucc:PartyIdentificationType"/>
        <xsd:element name="inventoryLocation" type="eanucc:PartyIdentificationType" minOccurs="0"/>
        <xsd:element name="purchaseOrder" type="eanucc:DocumentReferenceType" minOccurs="0"/>
        <xsd:element name="purchaseConditions" type="eanucc:DocumentReferenceType" minOccurs="0"/>
        <xsd:element name="deliveryNote" type="eanucc:ReferenceType" minOccurs="0"/>
        <xsd:element name="contract" type="eanucc:ReferenceType" minOccurs="0"/>
        <xsd:element name="productCertification" type="eanucc:ReferenceType" minOccurs="0"/>
        <xsd:element name="specification" type="eanucc:ReferenceType" minOccurs="0"/>
        <xsd:element name="declarantsCustomsIdentity" type="eanucc:ReferenceType" minOccurs="0"/>
        <xsd:element name="consignmentInformation" type="deliver:ConsignmentInformationType" minOccurs="0"/>
        <xsd:element name="deliveryAndTransportInformation" type="deliver:DeliveryAndTransportInformationType"
minOccurs="0"/>
        <xsd:element name="despatchInformation" type="deliver:DespatchInformationType"/>
        <xsd:choice>
          <xsd:element name="despatchAdviceLogisticUnitLinItem"
type="deliver:DespatchAdviceLogisticUnitLinItemType" maxOccurs="unbounded"/>
          <xsd:element name="despatchAdviceItemContainmentLinItem"
type="deliver:DespatchAdviceItemContainmentLinItemType" maxOccurs="unbounded"/>
        </xsd:choice>
        <xsd:element name="extension" type="eanucc:ExtensionType" minOccurs="0"/>
      </xsd:sequence>
    </xsd:extension>
  </xsd:complexContent>
</xsd:complexType>

```

element **DespatchAdviceType/despatchAdviceIdentification**

diagram

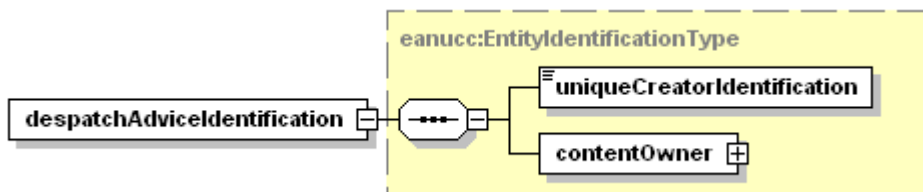

type [eanucc:EntityIdentificationType](#)

children [uniqueCreatorIdentification](#) [contentOwner](#)

source `<xsd:element name="despatchAdviceIdentification" type="eanucc:EntityIdentificationType"/>`

element **DespatchAdviceType/shipFrom**

diagram

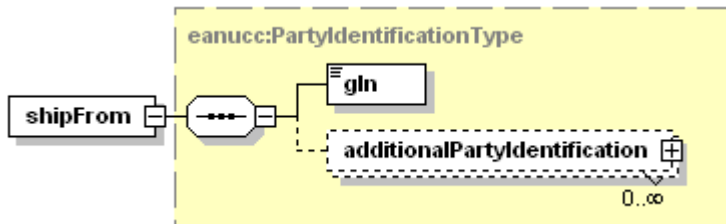

type [eanucc:PartyIdentificationType](#)

children [gln](#) [additionalPartyIdentification](#)

source `<xsd:element name="shipFrom" type="eanucc:PartyIdentificationType" minOccurs="0"/>`

element **DespatchAdviceType/shipTo**

diagram

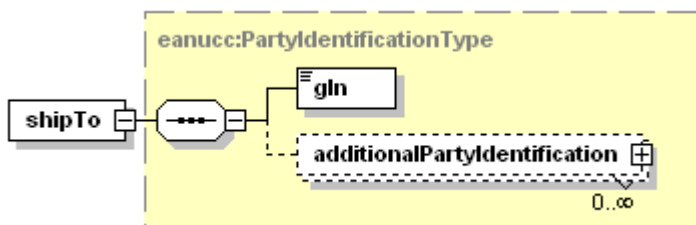

type [eanucc:PartyIdentificationType](#)

children [gln](#) [additionalPartyIdentification](#)

source `<xsd:element name="shipTo" type="eanucc:PartyIdentificationType"/>`

element **DespatchAdviceType/receiver**

diagram

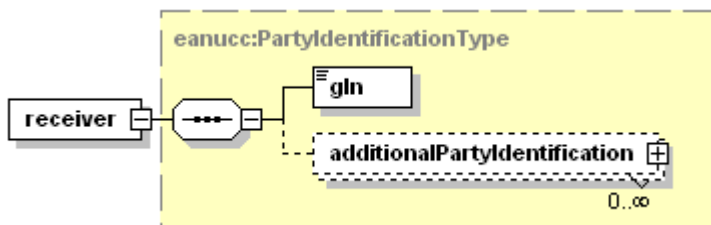

type [eanucc:PartyIdentificationType](#)

children [gln](#) [additionalPartyIdentification](#)

source `<xsd:element name="receiver" type="eanucc:PartyIdentificationType"/>`

element **DespatchAdviceType/carrier**

diagram

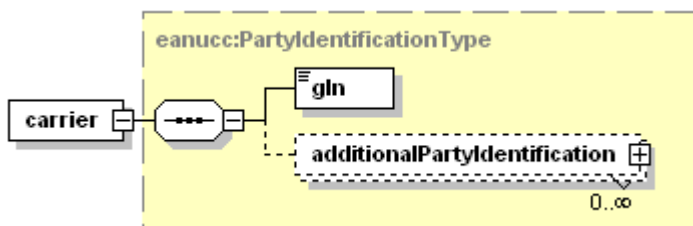

type [eanucc:PartyIdentificationType](#)

children [gln additionalPartyIdentification](#)

source `<xsd:element name="carrier" type="eanucc:PartyIdentificationType" minOccurs="0"/>`

element **DespatchAdviceType/pickUpLocation**

diagram

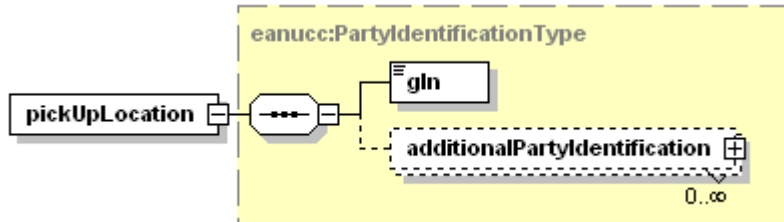

type [eanucc:PartyIdentificationType](#)

children [gln additionalPartyIdentification](#)

source `<xsd:element name="pickUpLocation" type="eanucc:PartyIdentificationType" minOccurs="0"/>`

element **DespatchAdviceType/shipper**

diagram

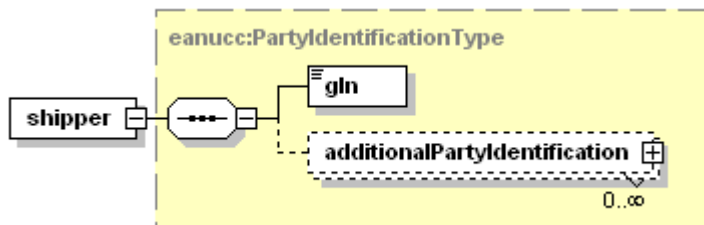

type [eanucc:PartyIdentificationType](#)

children [gln additionalPartyIdentification](#)

source `<xsd:element name="shipper" type="eanucc:PartyIdentificationType"/>`

element **DespatchAdviceType/inventoryLocation**

diagram

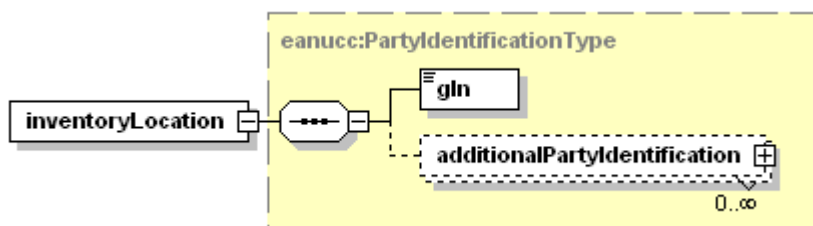

type [eanucc:PartyIdentificationType](#)

children [gln additionalPartyIdentification](#)

source `<xsd:element name="inventoryLocation" type="eanucc:PartyIdentificationType" minOccurs="0"/>`

element **DespatchAdviceType/purchaseOrder**

diagram

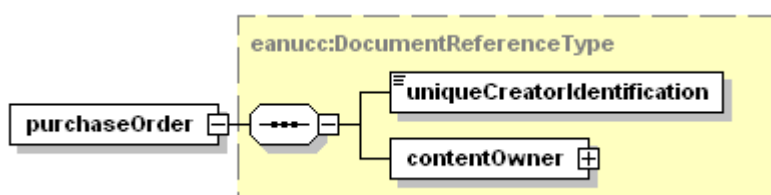

type [eanucc:DocumentReferenceType](#)

children [uniqueCreatorIdentification](#) [contentOwner](#)

attributes	Name	Type	Use	Default	Fixed	Annotation
	creationDateTim	xsd:dateTime				

source `<xsd:element name="purchaseOrder" type="eanucc:DocumentReferenceType" minOccurs="0"/>`

element **DespatchAdviceType/purchaseConditions**

diagram

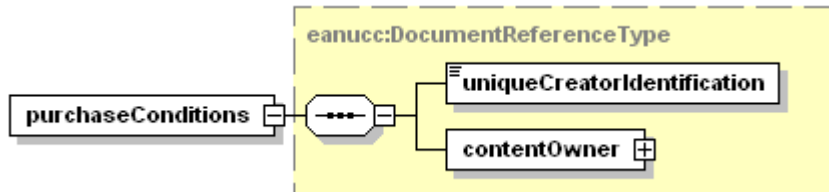

type [eanucc:DocumentReferenceType](#)

children [uniqueCreatorIdentification](#) [contentOwner](#)

attributes	Name	Type	Use	Default	Fixed	Annotation
	creationDateTim	xsd:dateTime				

source `<xsd:element name="purchaseConditions" type="eanucc:DocumentReferenceType" minOccurs="0"/>`

element **DespatchAdviceType/deliveryNote**

diagram

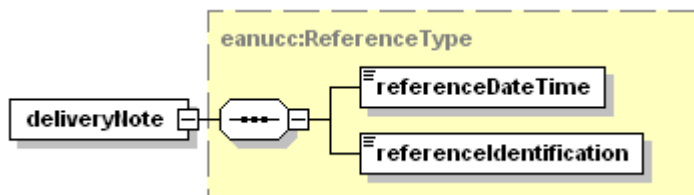

type [eanucc:ReferenceType](#)

children [referenceDateTime](#) [referenceIdentification](#)

source `<xsd:element name="deliveryNote" type="eanucc:ReferenceType" minOccurs="0"/>`

element **DespatchAdviceType/contract**

diagram

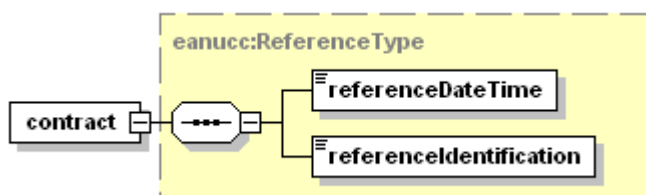

type [eanucc:ReferenceType](#)

children [referenceDateTime](#) [referenceIdentification](#)

source `<xsd:element name="contract" type="eanucc:ReferenceType" minOccurs="0"/>`

element **DespatchAdviceType/productCertification**

diagram

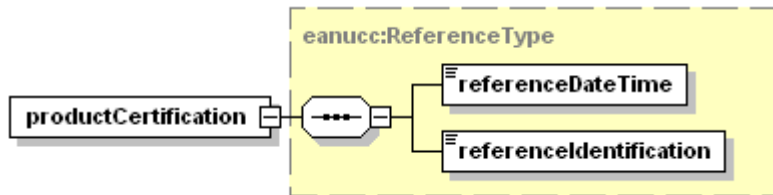

type [eanucc:ReferenceType](#)

children [referenceDateTime](#) [referenceIdentification](#)

source `<xsd:element name="productCertification" type="eanucc:ReferenceType" minOccurs="0"/>`

element **DespatchAdviceType/specification**

diagram

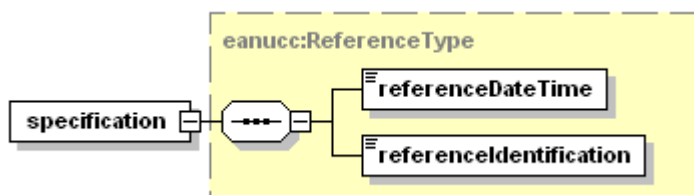

type [eanucc:ReferenceType](#)

children [referenceDateTime](#) [referenceIdentification](#)

source `<xsd:element name="specification" type="eanucc:ReferenceType" minOccurs="0"/>`

element **DespatchAdviceType/declarantsCustomsIdentity**

diagram

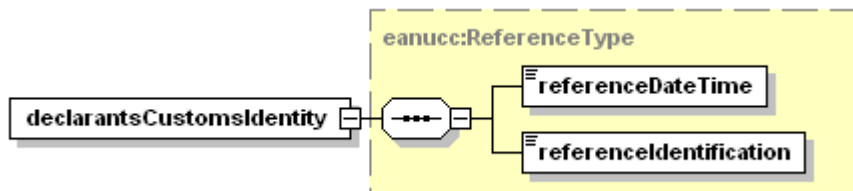

type [eanucc:ReferenceType](#)

children [referenceDateTime](#) [referenceIdentification](#)

source `<xsd:element name="declarantsCustomsIdentity" type="eanucc:ReferenceType" minOccurs="0"/>`

element **DespatchAdviceType/consignmentInformation**

diagram

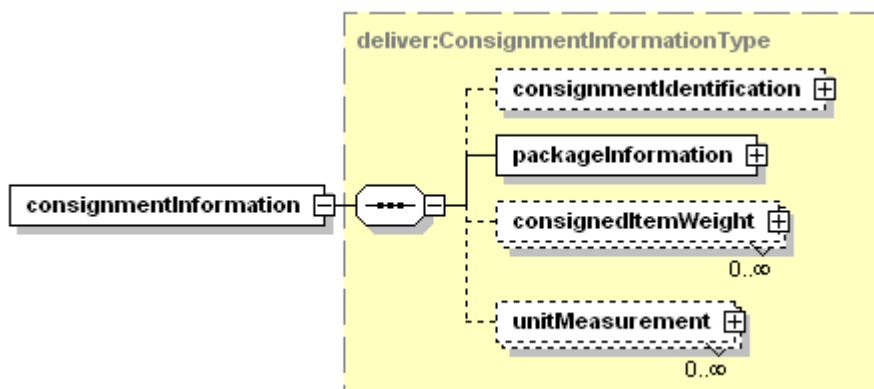

type [deliver:ConsignmentInformationType](#)
 children [consignmentIdentification](#) [packageInformation](#) [consignedItemWeight](#) [unitMeasurement](#)
 source `<xsd:element name="consignmentInformation" type="deliver:ConsignmentInformationType" minOccurs="0"/>`

element **DespatchAdviceType/deliveryAndTransportInformation**

diagram

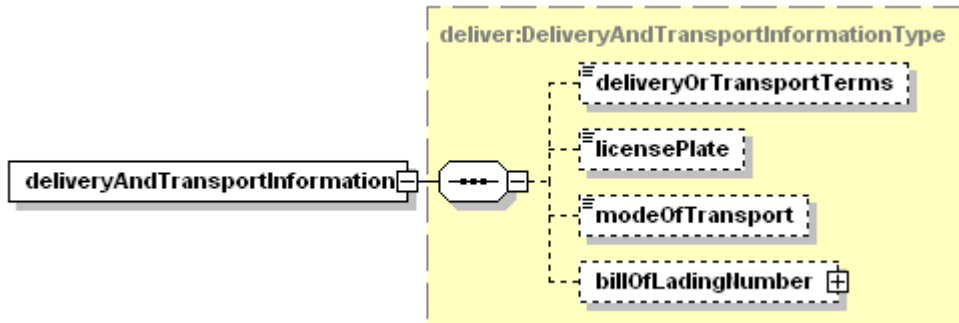

type [deliver:DeliveryAndTransportInformationType](#)
 children [deliveryOrTransportTerms](#) [licensePlate](#) [modeOfTransport](#) [billOfLadingNumber](#)
 source `<xsd:element name="deliveryAndTransportInformation" type="deliver:DeliveryAndTransportInformationType" minOccurs="0"/>`

element **DespatchAdviceType/despatchInformation**

diagram

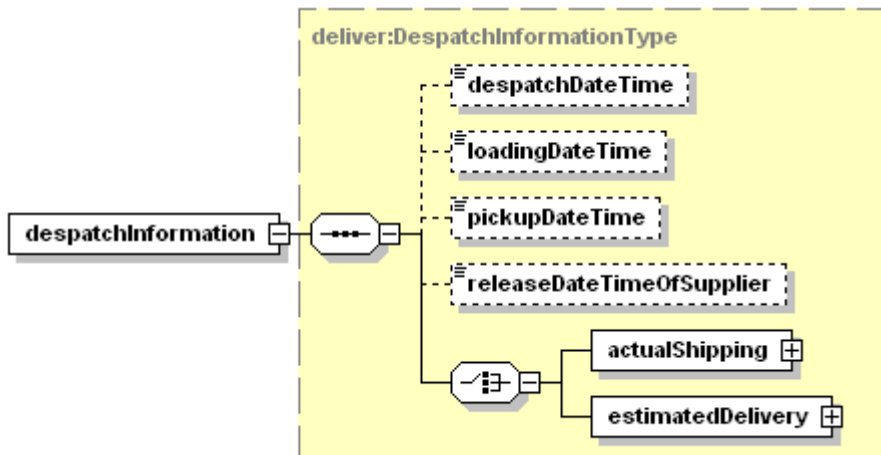

type [deliver:DespatchInformationType](#)
 children [despatchDateTime](#) [loadingDateTime](#) [pickupDateTime](#) [releaseDateTimeOfSupplier](#) [actualShipping](#) [estimatedDelivery](#)
 source `<xsd:element name="despatchInformation" type="deliver:DespatchInformationType"/>`

element **DespatchAdviceType/despatchAdviceLogisticUnitLineItem**

diagram

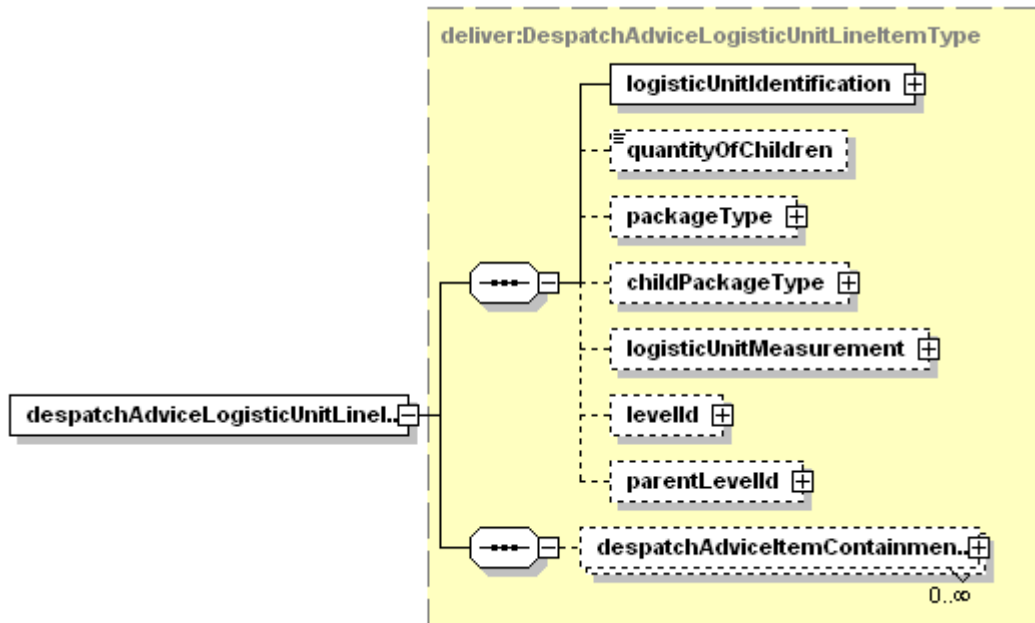

type [deliver:DespatchAdviceLogisticUnitLineItemType](#)

children [logisticUnitIdentification](#) [quantityOfChildren](#) [packageType](#) [childPackageType](#) [logisticUnitMeasurement](#) [levelId](#) [parentLevelId](#) [despatchAdviceItemContainmentLineItem](#)

source `<xsd:element name="despatchAdviceLogisticUnitLineItem" type="deliver:DespatchAdviceLogisticUnitLineItemType" maxOccurs="unbounded"/>`

element **DespatchAdviceType/despatchAdviceItemContainmentLineItem**

diagram

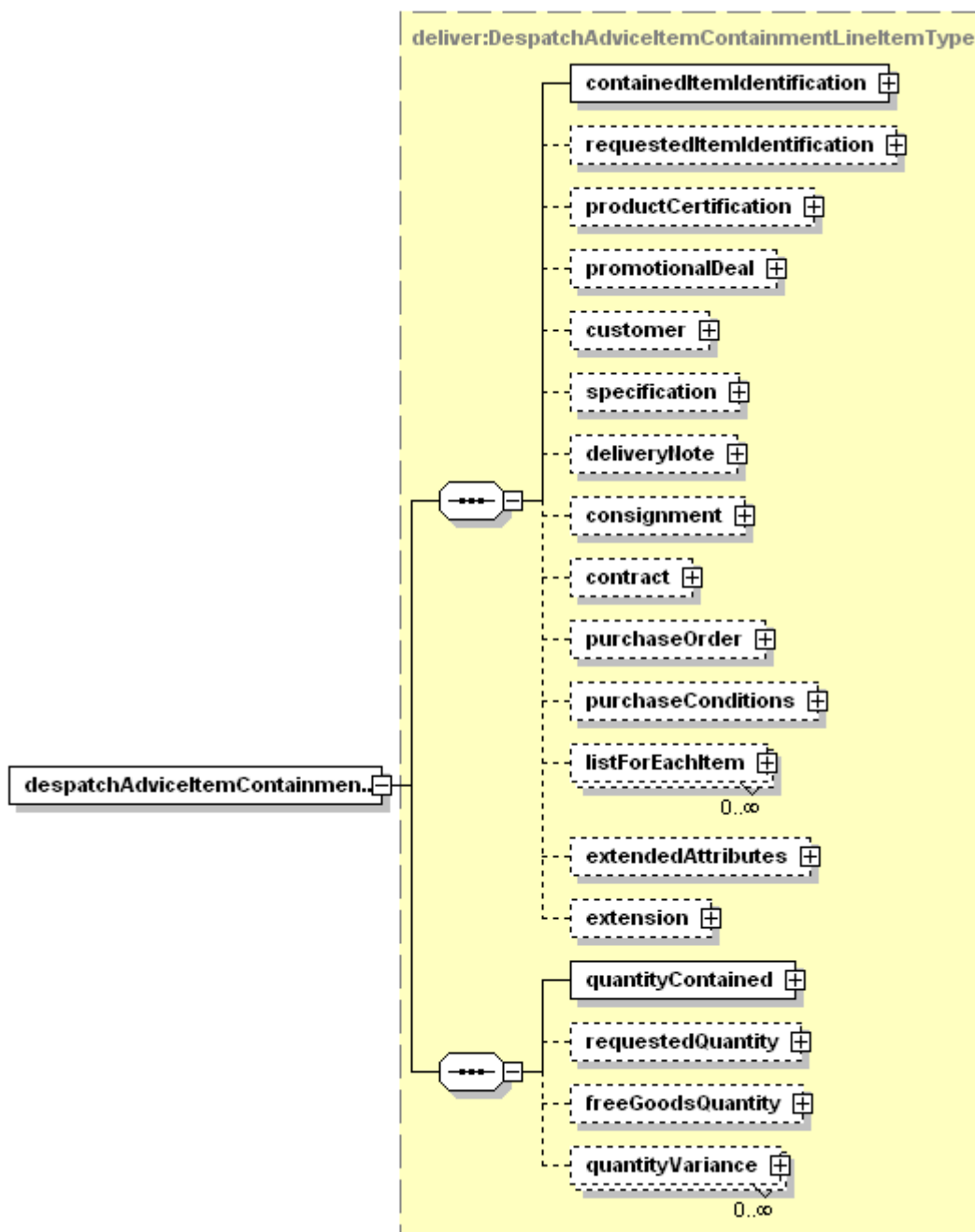

type [deliver:DespatchAdviceItemContainmentLineItemType](#)

children [containedItemIdentification](#) [requestedItemIdentification](#) [productCertification](#) [promotionalDeal](#) [customer](#) [specification](#) [deliveryNote](#) [consignment](#) [contract](#) [purchaseOrder](#) [purchaseConditions](#) [listForEachItem](#) [extendedAttributes](#) [extension](#) [quantityContained](#) [requestedQuantity](#) [freeGoodsQuantity](#) [quantityVariance](#)

attributes	Name	Type	Use	Default	Fixed	Annotation
	number	xsd:nonNegative Integer	required			

source `<xsd:element name="despatchAdviceItemContainmentLineItem" type="deliver:DespatchAdviceItemContainmentLineItemType" maxOccurs="unbounded"/>`

element **DespatchAdviceType/extension**

diagram

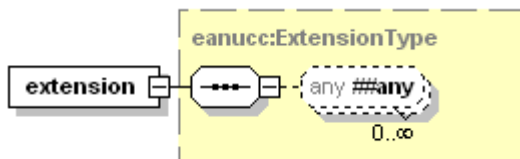

type [eanucc:ExtensionType](#)

source `<xsd:element name="extension" type="eanucc:ExtensionType" minOccurs="0"/>`

complexType **DespatchInformationType**

diagram

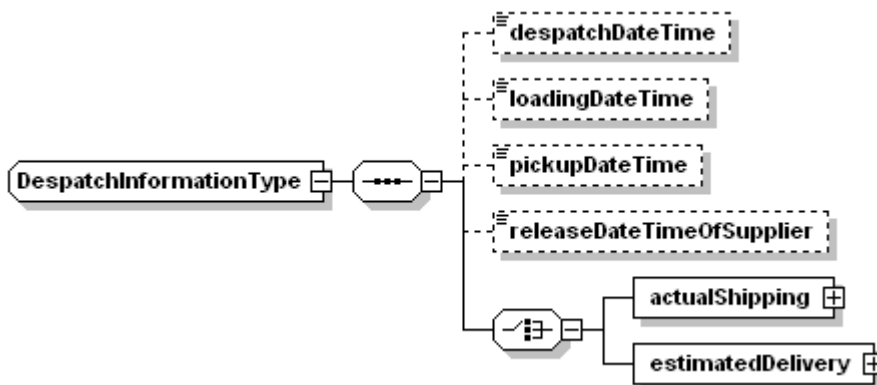

namespace `urn:ean.ucc:deliver:2`

children [despatchDateTime](#) [loadingDateTime](#) [pickupDateTime](#) [releaseDateTimeOfSupplier](#) [actualShipping](#) [estimatedDelivery](#)

used by element [DespatchAdviceType/despatchInformation](#)

```
<xsd:complexType name="DespatchInformationType">
  <xsd:sequence>
    <xsd:element name="despatchDateTime" type="xsd:dateTime" minOccurs="0"/>
    <xsd:element name="loadingDateTime" type="xsd:dateTime" minOccurs="0"/>
    <xsd:element name="pickupDateTime" type="xsd:dateTime" minOccurs="0"/>
    <xsd:element name="releaseDateTimeOfSupplier" type="xsd:dateTime" minOccurs="0"/>
    <xsd:choice>
      <xsd:element name="actualShipping" type="deliver:ActualShippingType"/>
      <xsd:element name="estimatedDelivery" type="deliver:EstimatedDeliveryType"/>
    </xsd:choice>
  </xsd:sequence>
</xsd:complexType>
```

element **DespatchInformationType/despatchDateTime**

diagram



type `xsd:dateTime`

source `<xsd:element name="despatchDateTime" type="xsd:dateTime" minOccurs="0"/>`

element **DespatchInformationType/loadingDateTime**

diagram



type `xsd:dateTime`

source `<xsd:element name="loadingDateTime" type="xsd:dateTime" minOccurs="0"/>`

element **DespatchInformationType/pickupDateTime**



type **xsd:dateTime**

source `<xsd:element name="pickupDateTime" type="xsd:dateTime" minOccurs="0"/>`

element **DespatchInformationType/releaseDateTimeOfSupplier**

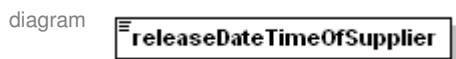

type **xsd:dateTime**

source `<xsd:element name="releaseDateTimeOfSupplier" type="xsd:dateTime" minOccurs="0"/>`

element **DespatchInformationType/actualShipping**

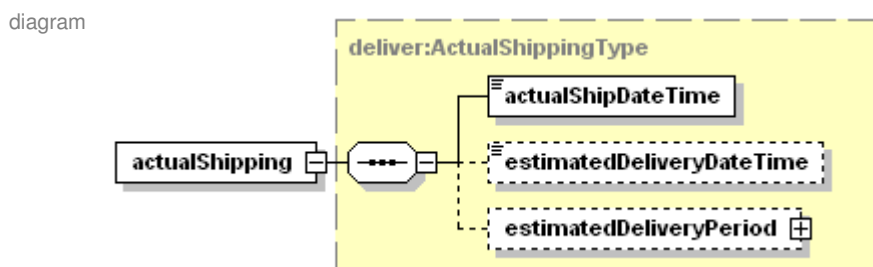

type [deliver:ActualShippingType](#)

children [actualShipDateTime](#) [estimatedDeliveryDateTime](#) [estimatedDeliveryPeriod](#)

source `<xsd:element name="actualShipping" type="deliver:ActualShippingType"/>`

element **DespatchInformationType/estimatedDelivery**

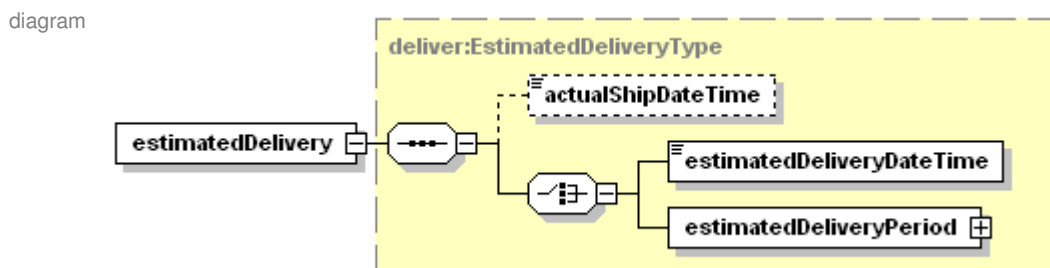

type [deliver:EstimatedDeliveryType](#)

children [actualShipDateTime](#) [estimatedDeliveryDateTime](#) [estimatedDeliveryPeriod](#)

source `<xsd:element name="estimatedDelivery" type="deliver:EstimatedDeliveryType"/>`

complexType **EstimatedDeliveryType**

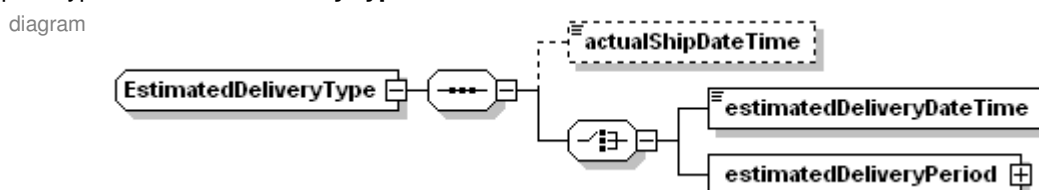

namespace urn:ean.ucc:deliver:2

children [actualShipDateTime](#) [estimatedDeliveryDateTime](#) [estimatedDeliveryPeriod](#)

used by element [DespatchInformationType/estimatedDelivery](#)

```
source <xsd:complexType name="EstimatedDeliveryType">
  <xsd:sequence>
    <xsd:element name="actualShipDateTime" type="xsd:dateTime" minOccurs="0"/>
    <xsd:choice>
      <xsd:element name="estimatedDeliveryDateTime" type="xsd:dateTime"/>
      <xsd:element name="estimatedDeliveryPeriod" type="eanucc:TimeOrDateTimePeriodType"/>
    </xsd:choice>
  </xsd:sequence>
</xsd:complexType>
```

element [EstimatedDeliveryType/actualShipDateTime](#)

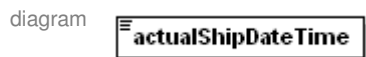

type **xsd:dateTime**

```
source <xsd:element name="actualShipDateTime" type="xsd:dateTime" minOccurs="0"/>
```

element [EstimatedDeliveryType/estimatedDeliveryDateTime](#)



type **xsd:dateTime**

```
source <xsd:element name="estimatedDeliveryDateTime" type="xsd:dateTime"/>
```

element [EstimatedDeliveryType/estimatedDeliveryPeriod](#)

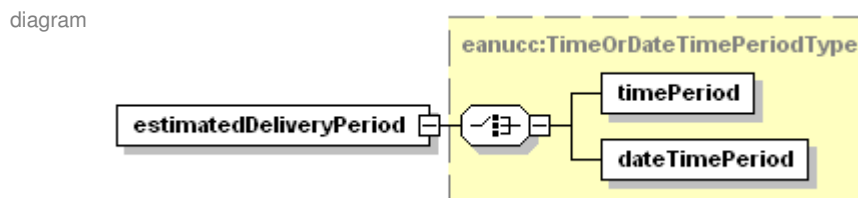

type [eanucc:TimeOrDateTimePeriodType](#)

children [timePeriod](#) [dateTimePeriod](#)

```
source <xsd:element name="estimatedDeliveryPeriod" type="eanucc:TimeOrDateTimePeriodType"/>
```

complexType [PackageInformationType](#)

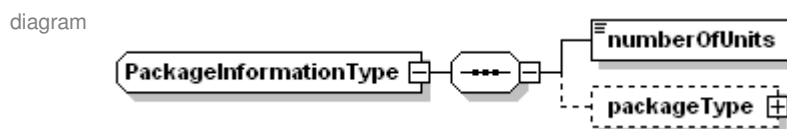

namespace urn:ean.ucc:deliver:2

children [numberOfUnits](#) [packageType](#)

used by element [ConsignmentInformationType/packageInformation](#)

```
source <xsd:complexType name="PackageInformationType">
  <xsd:sequence>
    <xsd:element name="numberOfUnits" type="xsd:integer"/>
    <xsd:element name="packageType" type="deliver:PackageTypeDescriptionCodeType" minOccurs="0"/>
  </xsd:sequence>
</xsd:complexType>
```

element **PackageInformationType/numberOfUnits**

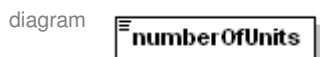

type **xsd:integer**

source `<xsd:element name="numberOfUnits" type="xsd:integer"/>`

element **PackageInformationType/packageType**

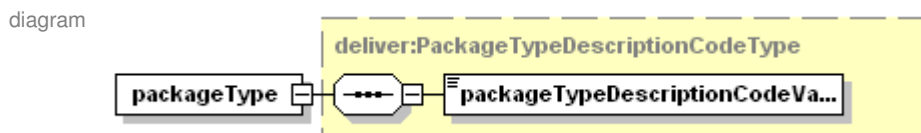

type [deliver:PackageTypeDescriptionCodeType](#)

children [packageTypeDescriptionCodeValue](#)

source `<xsd:element name="packageType" type="deliver:PackageTypeDescriptionCodeType" minOccurs="0"/>`

complexType **QuantityVarianceType**

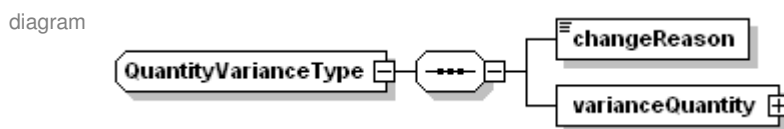

namespace urn:ean.ucc:deliver:2

children [changeReason](#) [varianceQuantity](#)

used by element [DespatchAdviceItemContainmentLineItem/quantityVariance](#)

source

```
<xsd:complexType name="QuantityVarianceType">
  <xsd:sequence>
    <xsd:element name="changeReason" type="deliver:ChangeReasonCodeListType"/>
    <xsd:element name="varianceQuantity" type="eanucc:QuantityType"/>
  </xsd:sequence>
</xsd:complexType>
```

element **QuantityVarianceType/changeReason**



type [deliver:ChangeReasonCodeListType](#)

facets

- enumeration ITEM_NOT_ORDERED
- enumeration ARTICLE_CODE_UNKNOWN
- enumeration OUT_OF_INVENTORY
- enumeration DAMAGED
- enumeration PACK_DIFFERENCE

source `<xsd:element name="changeReason" type="deliver:ChangeReasonCodeListType"/>`

element **QuantityVarianceType/varianceQuantity**

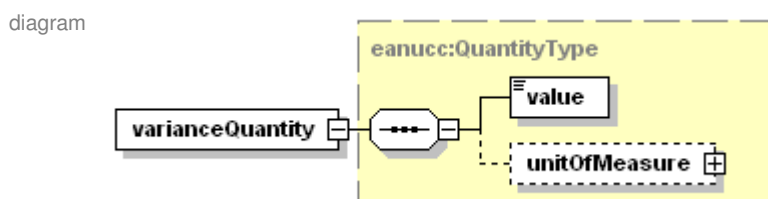

type [eanucc:QuantityType](#)
 children [value unitOfMeasure](#)
 source `<xsd:element name="varianceQuantity" type="eanucc:QuantityType"/>`

complexType **deliver:LevelIdentificationType**

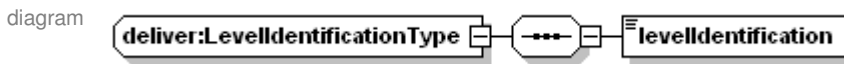

namespace urn:ean.ucc:deliver:2
 children [levelIdentification](#)
 used by elements [deliver:LogisticUnitsType/levelld](#) [deliver:LogisticUnitsType/parentLevelld](#)

source `<xsd:complexType name="LevelIdentificationType">
 <xsd:sequence>
 <xsd:element name="levelIdentification" type="xsd:integer"/>
 </xsd:sequence>
 </xsd:complexType>`

element **deliver:LevelIdentificationType/levelIdentification**



type **xsd:integer**
 source `<xsd:element name="levelIdentification" type="xsd:integer"/>`

complexType **deliver:LogisticUnitsType**

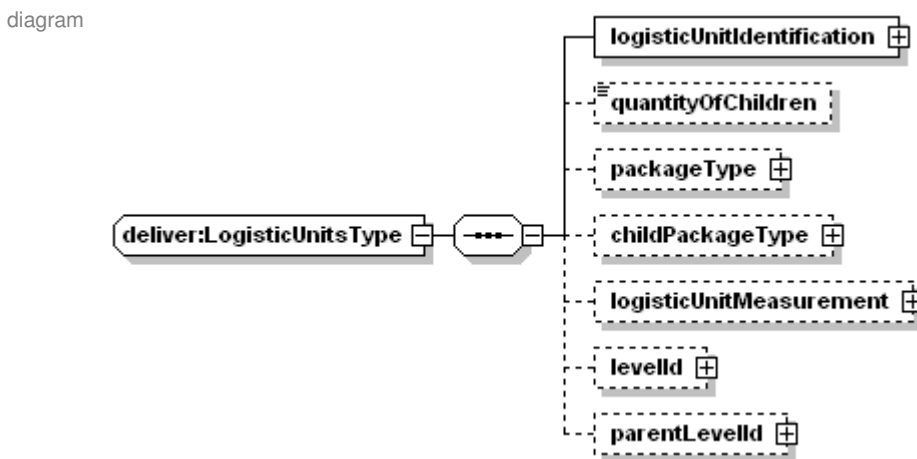

namespace urn:ean.ucc:deliver:2
 children [logisticUnitIdentification](#) [quantityOfChildren](#) [packageType](#) [childPackageType](#) [logisticUnitMeasurement](#) [levelld](#) [parentLevelld](#)
 used by complexType [DespatchAdviceLogisticUnitLineItem](#)

source `<xsd:complexType name="LogisticUnitsType">
 <xsd:sequence>
 <xsd:element name="logisticUnitIdentification" type="eanucc:LogisticUnitIdentificationType"/>
 <xsd:element name="quantityOfChildren" type="xsd:integer" minOccurs="0"/>
 <xsd:element name="packageType" type="deliver:PackageTypeDescriptionCodeType" minOccurs="0"/>
 <xsd:element name="childPackageType" type="deliver:PackageTypeDescriptionCodeType" minOccurs="0"/>
 <xsd:element name="logisticUnitMeasurement" type="deliver:LogisticUnitMeasurementType" minOccurs="0"/>
 <xsd:element name="levelld" type="deliver:LevelIdentificationType" minOccurs="0"/>
 <xsd:element name="parentLevelld" type="deliver:LevelIdentificationType" minOccurs="0"/>
 </xsd:sequence>
 </xsd:complexType>`

element **deliver:LogisticUnitsType/logisticUnitIdentification**

diagram

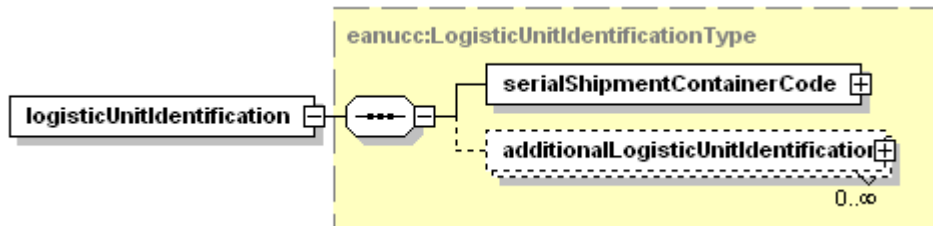

type [eanucc:LogisticUnitIdentificationType](#)

children [serialShipmentContainerCode](#) [additionalLogisticUnitIdentification](#)

source `<xsd:element name="logisticUnitIdentification" type="eanucc:LogisticUnitIdentificationType"/>`

element **deliver:LogisticUnitsType/quantityOfChildren**

diagram

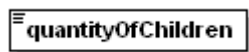

type **xsd:integer**

source `<xsd:element name="quantityOfChildren" type="xsd:integer" minOccurs="0"/>`

element **deliver:LogisticUnitsType/packageType**

diagram

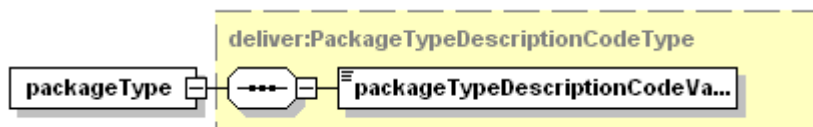

type [deliver:PackageTypeDescriptionCodeType](#)

children [packageTypeDescriptionCodeValue](#)

source `<xsd:element name="packageType" type="deliver:PackageTypeDescriptionCodeType" minOccurs="0"/>`

element **deliver:LogisticUnitsType/childPackageType**

diagram

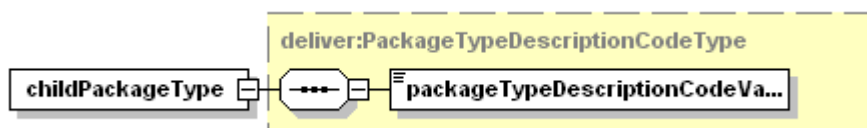

type [deliver:PackageTypeDescriptionCodeType](#)

children [packageTypeDescriptionCodeValue](#)

source `<xsd:element name="childPackageType" type="deliver:PackageTypeDescriptionCodeType" minOccurs="0"/>`

element **deliver:LogisticUnitsType/logisticUnitMeasurement**

diagram

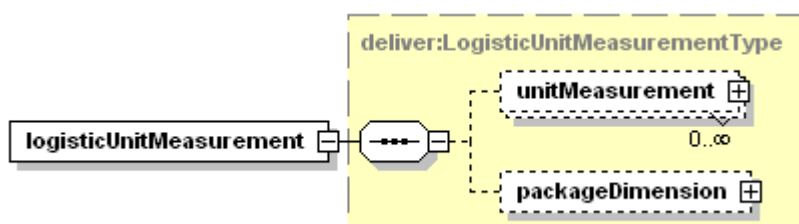

type [deliver:LogisticUnitMeasurementType](#)
 children [unitMeasurement](#) [packageDimension](#)
 source `<xsd:element name="logisticUnitMeasurement" type="deliver:LogisticUnitMeasurementType" minOccurs="0"/>`

element **deliver:LogisticUnitsType/levelId**

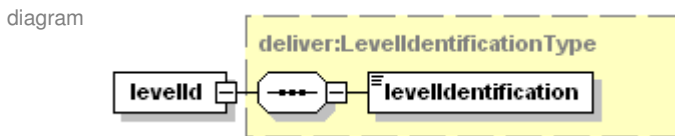

type [deliver:LevelIdentificationType](#)
 children [levelIdentification](#)
 source `<xsd:element name="levelId" type="deliver:LevelIdentificationType" minOccurs="0"/>`

element **deliver:LogisticUnitsType/parentLevelId**

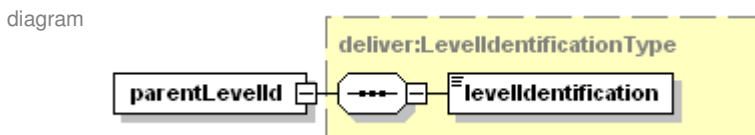

type [deliver:LevelIdentificationType](#)
 children [levelIdentification](#)
 source `<xsd:element name="parentLevelId" type="deliver:LevelIdentificationType" minOccurs="0"/>`

simpleType **deliver:IncotermCodeListType**

namespace urn:ean.ucc:deliver:2

type restriction of **xsd:string**

used by element [DeliveryAndTransportInformationType/deliveryOrTransportTerms](#)

- facets
- enumeration CFR
 - enumeration CIF
 - enumeration CIP
 - enumeration CPT
 - enumeration DAF
 - enumeration DDP
 - enumeration DDU
 - enumeration DES
 - enumeration DEQ
 - enumeration EXW
 - enumeration FAS
 - enumeration FCA
 - enumeration FOB

source `<xsd:simpleType name="IncotermCodeListType">
 <xsd:restriction base="xsd:string">
 <xsd:enumeration value="CFR"/>
 <xsd:enumeration value="CIF"/>
 <xsd:enumeration value="CIP"/>
 <xsd:enumeration value="CPT"/>
 <xsd:enumeration value="DAF"/>
 <xsd:enumeration value="DDP"/>
 <xsd:enumeration value="DDU"/>
 <xsd:enumeration value="DES"/>
 <xsd:enumeration value="DEQ"/>
 <xsd:enumeration value="EXW"/>
 <xsd:enumeration value="FAS"/>
 <xsd:enumeration value="FCA"/>
 <xsd:enumeration value="FOB"/>
 </xsd:restriction>
 </xsd:simpleType>`

complexType **deliver:AdditionalItemType**

diagram

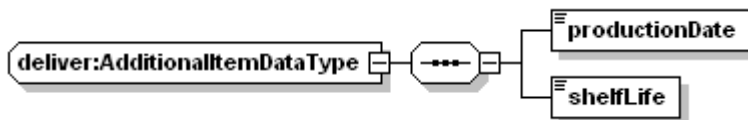

namespace urn:ean.ucc:deliver:2

children [productionDate](#) [shelfLife](#)

```
source <xsd:complexType name="AdditionalItemType">
  <xsd:sequence>
    <xsd:element name="productionDate" type="xsd:date"/>
    <xsd:element name="shelfLife" type="xsd:string"/>
  </xsd:sequence>
</xsd:complexType>
```

element **deliver:AdditionalItemType/productionDate**

diagram

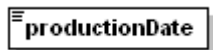

type **xsd:date**

```
source <xsd:element name="productionDate" type="xsd:date"/>
```

element **deliver:AdditionalItemType/shelfLife**

diagram



type **xsd:string**

```
source <xsd:element name="shelfLife" type="xsd:string"/>
```

complexType deliver:ItemContainmentType

diagram



namespace urn:ean.ucc:deliver:2

type extension of [eanucc:LineItemType](#)

children [containedItemIdentification](#) [requestedItemIdentification](#) [productCertification](#) [promotionalDeal](#) [customer](#) [specification](#) [deliveryNote](#) [consignment](#) [contract](#) [purchaseOrder](#) [purchaseConditions](#) [listForEachItem](#) [extendedAttributes](#) [extension](#)

used by element [deliver:TradeItemUnitType/ItemContained](#)
complexType [DespatchAdviceItemContainmentLineItemType](#)

attributes	Name	Type	Use	Default	Fixed	Annotation
	number	xsd:nonNegative Integer	required			

```

source <xsd:complexType name="ItemContainmentType">
  <xsd:complexContent>
    <xsd:extension base="eanucc:LineItemType">
      <xsd:sequence>
        <xsd:element name="containedItemIdentification" type="eanucc:TradeItemIdentificationType"/>
        <xsd:element name="requestedItemIdentification" type="eanucc:TradeItemIdentificationType" minOccurs="0"/>
        <xsd:element name="productCertification" type="eanucc:DetailLevelReferenceType" minOccurs="0"/>
        <xsd:element name="promotionalDeal" type="eanucc:DetailLevelReferenceType" minOccurs="0"/>
        <xsd:element name="customer" type="eanucc:DetailLevelReferenceType" minOccurs="0"/>
        <xsd:element name="specification" type="eanucc:DetailLevelReferenceType" minOccurs="0"/>
        <xsd:element name="deliveryNote" type="eanucc:DetailLevelReferenceType" minOccurs="0"/>
        <xsd:element name="consignment" type="eanucc:DetailLevelReferenceType" minOccurs="0"/>
        <xsd:element name="contract" type="eanucc:DetailLevelReferenceType" minOccurs="0"/>
        <xsd:element name="purchaseOrder" type="eanucc:DocumentOrDocumentLineReferenceType" minOccurs="0"/>
        <xsd:element name="purchaseConditions" type="eanucc:DocumentOrDocumentLineReferenceType"
minOccurs="0"/>
        <xsd:element name="listForEachItem" type="deliver:SpecifItemDataType" minOccurs="0"
maxOccurs="unbounded"/>
        <xsd:element name="extendedAttributes" type="eanucc:TransactionallItemDataType" minOccurs="0"/>
        <xsd:element name="extension" type="eanucc:ExtensionType" minOccurs="0"/>
      </xsd:sequence>
    </xsd:extension>
  </xsd:complexContent>
</xsd:complexType>

```

```

</xsd:extension>
</xsd:complexContent>
</xsd:complexType>

```

element **deliver:ItemContainmentType/containedItemIdentification**

diagram

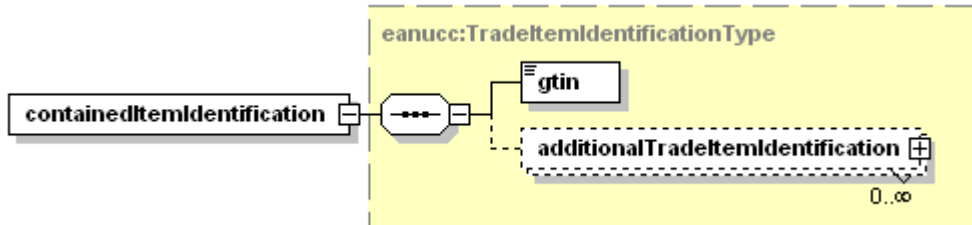

type [eanucc:TradeItemIdentificationType](#)

children [gtin](#) [additionalTradeItemIdentification](#)

source `<xsd:element name="containedItemIdentification" type="eanucc:TradeItemIdentificationType"/>`

element **deliver:ItemContainmentType/requestedItemIdentification**

diagram

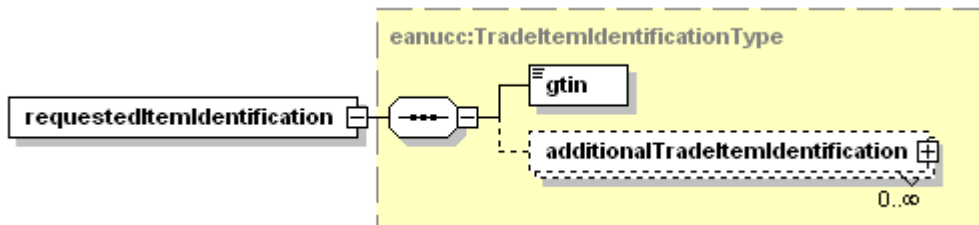

type [eanucc:TradeItemIdentificationType](#)

children [gtin](#) [additionalTradeItemIdentification](#)

source `<xsd:element name="requestedItemIdentification" type="eanucc:TradeItemIdentificationType" minOccurs="0"/>`

element **deliver:ItemContainmentType/productCertification**

diagram

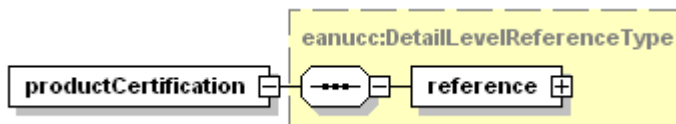

type [eanucc:DetailLevelReferenceType](#)

children [reference](#)

attributes	Name	Type	Use	Default	Fixed	Annotation
	number	xsd:nonNegative Integer	required			

source `<xsd:element name="productCertification" type="eanucc:DetailLevelReferenceType" minOccurs="0"/>`

element **deliver:ItemContainmentType/promotionalDeal**

diagram

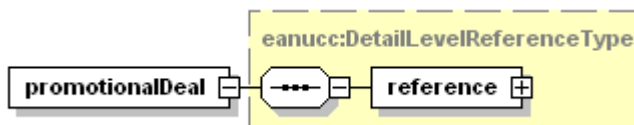

type [eanucc:DetailLevelReferenceType](#)

children [reference](#)

attributes	Name	Type	Use	Default	Fixed	Annotation
	number	xsd:nonNegative Integer	required			
source	<code><xsd:element name="promotionalDeal" type="eanucc:DetailLevelReferenceType" minOccurs="0"/></code>					

element `deliver:ItemContainmentType/customer`

diagram

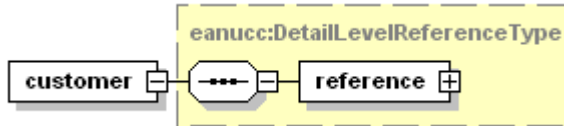

type [eanucc:DetailLevelReferenceType](#)

children [reference](#)

attributes	Name	Type	Use	Default	Fixed	Annotation
	number	xsd:nonNegative Integer	required			

source `<xsd:element name="customer" type="eanucc:DetailLevelReferenceType" minOccurs="0"/>`

element `deliver:ItemContainmentType/specification`

diagram

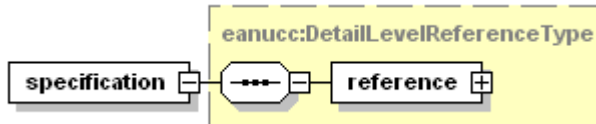

type [eanucc:DetailLevelReferenceType](#)

children [reference](#)

attributes	Name	Type	Use	Default	Fixed	Annotation
	number	xsd:nonNegative Integer	required			

source `<xsd:element name="specification" type="eanucc:DetailLevelReferenceType" minOccurs="0"/>`

element `deliver:ItemContainmentType/deliveryNote`

diagram

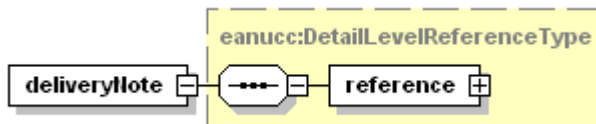

type [eanucc:DetailLevelReferenceType](#)

children [reference](#)

attributes	Name	Type	Use	Default	Fixed	Annotation
	number	xsd:nonNegative Integer	required			

source `<xsd:element name="deliveryNote" type="eanucc:DetailLevelReferenceType" minOccurs="0"/>`

element `deliver:ItemContainmentType/consignment`

diagram

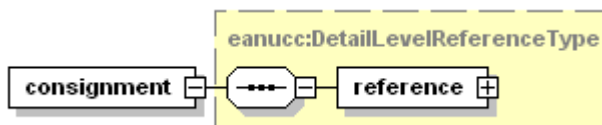

type [eanucc:DetailLevelReferenceType](#)

children [reference](#)

attributes	Name	Type	Use	Default	Fixed	Annotation
	number	xsd:nonNegative Integer	required			

Integer

source `<xsd:element name="consignment" type="eanucc:DetailLevelReferenceType" minOccurs="0"/>`

element `deliver:ItemContainmentType/contract`

diagram

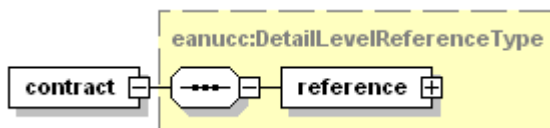

type [eanucc:DetailLevelReferenceType](#)

children [reference](#)

attributes	Name	Type	Use	Default	Fixed	Annotation
	number	xsd:nonNegative Integer	required			

source `<xsd:element name="contract" type="eanucc:DetailLevelReferenceType" minOccurs="0"/>`

element `deliver:ItemContainmentType/purchaseOrder`

diagram

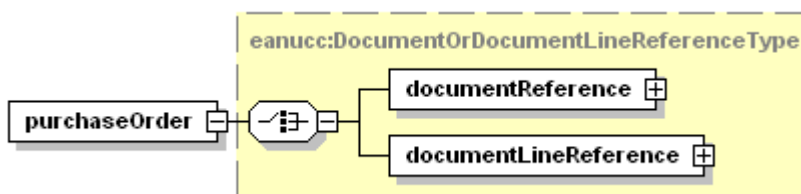

type [eanucc:DocumentOrDocumentLineReferenceType](#)

children [documentReference](#) [documentLineReference](#)

source `<xsd:element name="purchaseOrder" type="eanucc:DocumentOrDocumentLineReferenceType" minOccurs="0"/>`

element `deliver:ItemContainmentType/purchaseConditions`

diagram

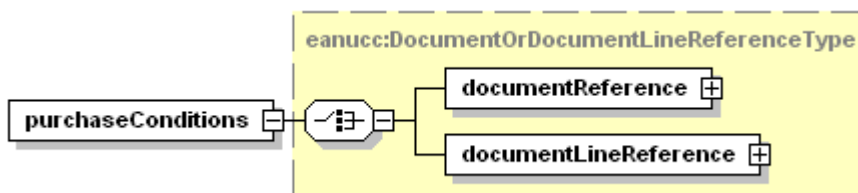

type [eanucc:DocumentOrDocumentLineReferenceType](#)

children [documentReference](#) [documentLineReference](#)

source `<xsd:element name="purchaseConditions" type="eanucc:DocumentOrDocumentLineReferenceType" minOccurs="0"/>`

element `deliver:ItemContainmentType/listForEachItem`

diagram

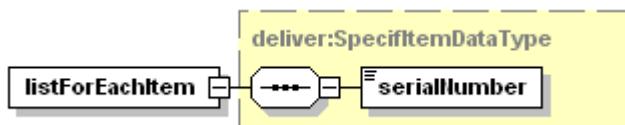

type [deliver:SpecifItemDataType](#)

children [serialNumber](#)

source `<xsd:element name="listForEachItem" type="deliver:SpecifItemDataType" minOccurs="0" maxOccurs="unbounded"/>`

element `deliver:ItemContainmentType/extendedAttributes`

diagram

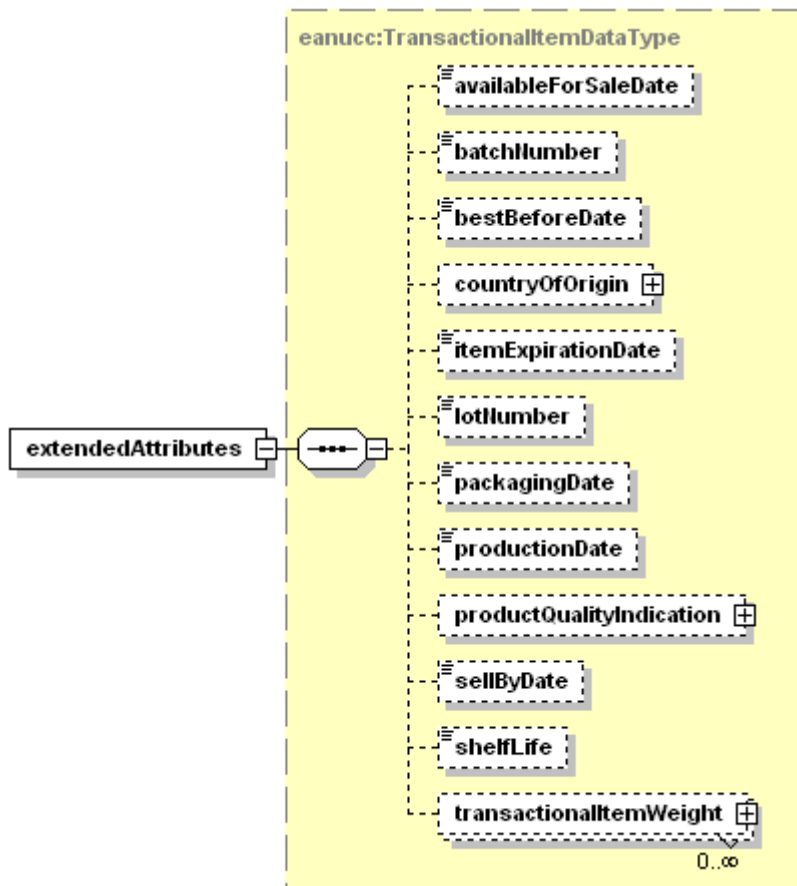

type [eanucc:TransactionalItemDataType](#)

children [availableForSaleDate](#) [batchNumber](#) [bestBeforeDate](#) [countryOfOrigin](#) [itemExpirationDate](#) [lotNumber](#) [packagingDate](#) [productionDate](#) [productQualityIndication](#) [sellByDate](#) [shelfLife](#) [transactionalItemWeight](#)

source `<xsd:element name="extendedAttributes" type="eanucc:TransactionalItemDataType" minOccurs="0"/>`

element `deliver:ItemContainmentType/extension`

diagram

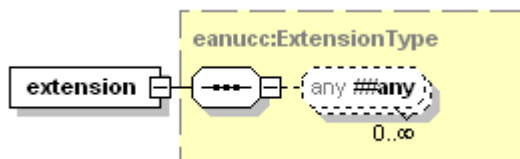

type [eanucc:ExtensionType](#)

source `<xsd:element name="extension" type="eanucc:ExtensionType" minOccurs="0"/>`

complexType `deliver:SpecifItemDataType`

diagram



namespace `urn:ean.ucc:deliver:2`

children [serialNumber](#)

used by element [deliver:ItemContainmentType/listForEachItem](#)

source `<xsd:complexType name="SpecifItemDataType">`

```
<xsd:sequence>
  <xsd:element name="serialNumber" type="xsd:string"/>
</xsd:sequence>
</xsd:complexType>
```

element **deliver:SpecifItemDataType/serialNumber**

diagram



type **xsd:string**

source `<xsd:element name="serialNumber" type="xsd:string"/>`

complexType **deliver:TradelItemUnitType**

diagram

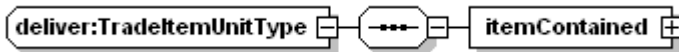

namespace urn:ean.ucc:deliver:2

children [itemContained](#)

```
source <xsd:complexType name="TradelItemUnitType">
  <xsd:sequence>
    <xsd:element name="itemContained" type="deliver:ItemContainmentType"/>
  </xsd:sequence>
</xsd:complexType>
```

element **deliver:TradelItemUnitType/itemContained**

diagram

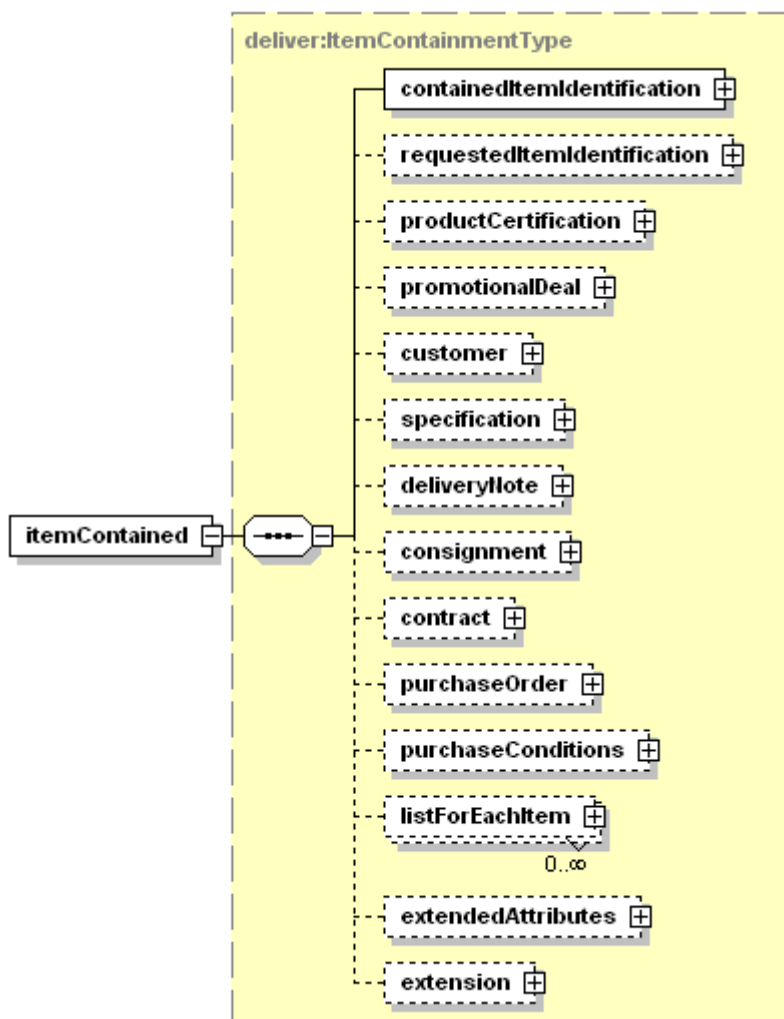

type [deliver:ItemContainmentType](#)

children [containedItemIdentification](#) [requestedItemIdentification](#) [productCertification](#) [promotionalDeal](#) [customer](#) [specification](#) [deliveryNote](#) [consignment](#) [contract](#) [purchaseOrder](#) [purchaseConditions](#) [listForEachItem](#) [extendedAttributes](#) [extension](#)

attributes	Name	Type	Use	Default	Fixed	Annotation
	number	xsd:nonNegative Integer	required			

source `<xsd:element name="itemContained" type="deliver:ItemContainmentType"/>`

simpleType **deliver:ChangeReasonCodeListType**

namespace urn:ean.ucc:deliver:2

type restriction of **xsd:string**

used by element [QuantityVarianceType/changeReason](#)

facets

- enumeration ITEM_NOT_ORDERED
- enumeration ARTICLE_CODE_UNKNOWN
- enumeration OUT_OF_INVENTORY
- enumeration DAMAGED
- enumeration PACK_DIFFERENCE

source `<xsd:simpleType name="ChangeReasonCodeListType">
 <xsd:restriction base="xsd:string">
 <xsd:enumeration value="ITEM_NOT_ORDERED"/>
 <xsd:enumeration value="ARTICLE_CODE_UNKNOWN"/>
 <xsd:enumeration value="OUT_OF_INVENTORY"/>
 </xsd:restriction>
 </xsd:simpleType>`

```

<xsd:enumeration value="DAMAGED"/>
<xsd:enumeration value="PACK_DIFFERENCE"/>
</xsd:restriction>
</xsd:simpleType>

```

complexType **deliver:PackageTypeDescriptionCodeType**

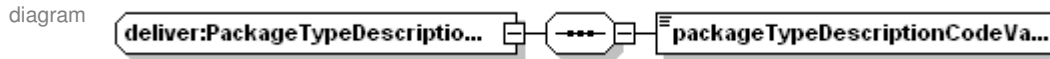

namespace urn:ean.ucc:deliver:2

children [packageTypeDescriptionCodeValue](#)

used by elements [deliver:LogisticUnitsType/childPackageType](#) [PackageInformationType/packageType](#)
[deliver:LogisticUnitsType/packageType](#)

source

```

<xsd:complexType name="PackageTypeDescriptionCodeType">
  <xsd:sequence>
    <xsd:element name="packageTypeDescriptionCodeValue">
      <xsd:simpleType>
        <xsd:restriction base="xsd:string">
          <xsd:maxLength value="3"/>
          <xsd:minLength value="1"/>
        </xsd:restriction>
      </xsd:simpleType>
    </xsd:element>
  </xsd:sequence>
</xsd:complexType>

```

element **deliver:PackageTypeDescriptionCodeType/packageTypeDescriptionCodeValue**

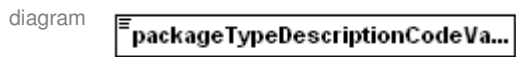

type restriction of **xsd:string**

facets
 minLength 1
 maxLength 3

source

```

<xsd:element name="packageTypeDescriptionCodeValue">
  <xsd:simpleType>
    <xsd:restriction base="xsd:string">
      <xsd:maxLength value="3"/>
      <xsd:minLength value="1"/>
    </xsd:restriction>
  </xsd:simpleType>
</xsd:element>

```

simpleType **eanucc:TransportationMethodTypeCodeListType**

namespace urn:ean.ucc:2

type restriction of **xsd:string**

used by element [DeliveryAndTransportInformationType/modeOfTransport](#)

facets

- enumeration AIR
- enumeration AIR_CHARTER
- enumeration AIR_EXPRESS
- enumeration AIR_FREIGHT
- enumeration BEST_WAY_SHIPPERS_OPTION
- enumeration BOOK_POSTAL
- enumeration BUS
- enumeration CAB
- enumeration CONSOLIDATION
- enumeration CONTRACT_CARRIER
- enumeration CUSTOMER_PICKUP
- enumeration CUSTOMER_PICKUP_OR_CUSTOMERS_EXPENSE
- enumeration EXPEDITED_TRUCK
- enumeration GEOGRAPHIC_RECEIVING
- enumeration GEOGRAPHIC_RECEIVING_SHIPPING
- enumeration GEOGRAPHIC_SHIPPING
- enumeration INLAND_WATERWAY
- enumeration INTERMODAL_PIGGYBACK

enumeration LESS_THAN_TRUCK_LOAD
enumeration MOTOR
enumeration MOTOR_COMMON_CARRIER
enumeration MOTOR_FLATBED
enumeration MOTOR_PACKAGE_CARRIER
enumeration MOTOR_TRUCKLOAD
enumeration MOTOR_VAN
enumeration MUTUALLY_DEFINED
enumeration OCEAN
enumeration PARCEL_POST
enumeration PIPELINE
enumeration POOLED_AIR
enumeration POOLED_PIGGYPACK
enumeration POOL_TO_POOL
enumeration POOLED_RAIL
enumeration POOLED_TRUCK
enumeration PRIVATE_CARRIER
enumeration PRIVATE_PARCEL_SERVICE
enumeration PRIVATE_VESSEL
enumeration RAIL
enumeration ROADRAILER
enumeration SEA_AIR
enumeration STEAM_SHIP
enumeration SUPPLIER_TRUCK

```
source <xsd:simpleType name="TransportationMethodTypeCodeListType">
  <xsd:restriction base="xsd:string">
    <xsd:enumeration value="AIR"/>
    <xsd:enumeration value="AIR_CHARTER"/>
    <xsd:enumeration value="AIR_EXPRESS"/>
    <xsd:enumeration value="AIR_FREIGHT"/>
    <xsd:enumeration value="BEST_WAY_SHIPPERS_OPTION"/>
    <xsd:enumeration value="BOOK_POSTAL"/>
    <xsd:enumeration value="BUS"/>
    <xsd:enumeration value="CAB"/>
    <xsd:enumeration value="CONSOLIDATION"/>
    <xsd:enumeration value="CONTRACT_CARRIER"/>
    <xsd:enumeration value="CUSTOMER_PICKUP"/>
    <xsd:enumeration value="CUSTOMER_PICKUP_OR_CUSTOMERS_EXPENSE"/>
    <xsd:enumeration value="EXPEDITED_TRUCK"/>
    <xsd:enumeration value="GEOGRAPHIC_RECEIVING"/>
    <xsd:enumeration value="GEOGRAPHIC_RECEIVING_SHIPPING"/>
    <xsd:enumeration value="GEOGRAPHIC_SHIPPING"/>
    <xsd:enumeration value="INLAND_WATERWAY"/>
    <xsd:enumeration value="INTERMODAL_PIGGYBACK"/>
    <xsd:enumeration value="LESS_THAN_TRUCK_LOAD"/>
    <xsd:enumeration value="MOTOR"/>
    <xsd:enumeration value="MOTOR_COMMON_CARRIER"/>
    <xsd:enumeration value="MOTOR_FLATBED"/>
    <xsd:enumeration value="MOTOR_PACKAGE_CARRIER"/>
    <xsd:enumeration value="MOTOR_TRUCKLOAD"/>
    <xsd:enumeration value="MOTOR_VAN"/>
    <xsd:enumeration value="MUTUALLY_DEFINED"/>
    <xsd:enumeration value="OCEAN"/>
    <xsd:enumeration value="PARCEL_POST"/>
    <xsd:enumeration value="PIPELINE"/>
    <xsd:enumeration value="POOLED_AIR"/>
    <xsd:enumeration value="POOLED_PIGGYPACK"/>
    <xsd:enumeration value="POOL_TO_POOL"/>
    <xsd:enumeration value="POOLED_RAIL"/>
    <xsd:enumeration value="POOLED_TRUCK"/>
    <xsd:enumeration value="PRIVATE_CARRIER"/>
    <xsd:enumeration value="PRIVATE_PARCEL_SERVICE"/>
    <xsd:enumeration value="PRIVATE_VESSEL"/>
    <xsd:enumeration value="RAIL"/>
    <xsd:enumeration value="ROADRAILER"/>
    <xsd:enumeration value="SEA_AIR"/>
    <xsd:enumeration value="STEAM_SHIP"/>
    <xsd:enumeration value="SUPPLIER_TRUCK"/>
  </xsd:restriction>
</xsd:simpleType>
```

complexType eanucc:TimeOrDateTimePeriodType

diagram

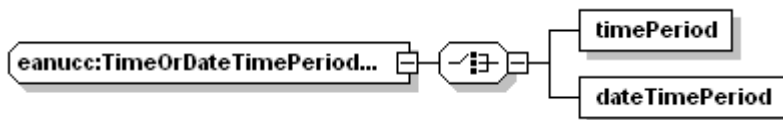

namespace urn:ean.ucc:2

children [timePeriod](#) [dateTimePeriod](#)

used by elements [EstimatedDeliveryType/estimatedDeliveryPeriod](#) [ActualShippingType/estimatedDeliveryPeriod](#)

```
<xsd:complexType name="TimeOrDateTimePeriodType">
  <xsd:choice>
    <xsd:element name="timePeriod" type="eanucc:TimePeriodType"/>
    <xsd:element name="dateTimePeriod" type="eanucc:DateTimePeriodType"/>
  </xsd:choice>
</xsd:complexType>
```

element eanucc:TimeOrDateTimePeriodType/timePeriod

diagram

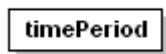

type [eanucc:TimePeriodType](#)

attributes	Name	Type	Use	Default	Fixed	Annotation
	beginDate	xsd:date	required			
	endDate	xsd:date	required			

source `<xsd:element name="timePeriod" type="eanucc:TimePeriodType"/>`

element eanucc:TimeOrDateTimePeriodType/dateTimePeriod

diagram



type [eanucc:DateTimePeriodType](#)

attributes	Name	Type	Use	Default	Fixed	Annotation
	beginDateTime	xsd:dateTime	required			
	endDateTime	xsd:dateTime	required			

source `<xsd:element name="dateTimePeriod" type="eanucc:DateTimePeriodType"/>`

complexType eanucc:QuantityType

diagram

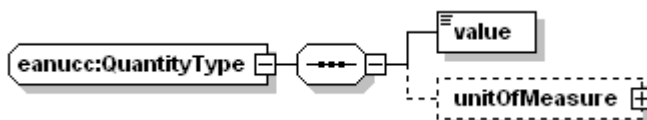

namespace urn:ean.ucc:2

children [value](#) [unitOfMeasure](#)

used by elements [DespatchAdviceItemContainmentLineItemType/freeGoodsQuantity](#) [eanucc:TransactionalItemDataType/productQualityIndication](#) [DespatchAdviceItemContainmentLineItemType/quantityContained](#) [DespatchAdviceItemContainmentLineItemType/requestedQuantity](#) [QuantityVarianceType/varianceQuantity](#)

```
<xsd:complexType name="QuantityType">
  <xsd:sequence>
    <xsd:element name="value" type="xsd:float"/>
    <xsd:element name="unitOfMeasure" type="eanucc:MeasurementUnitCodeType" minOccurs="0"/>
  </xsd:sequence>
</xsd:complexType>
```

element **eanucc:QuantityType/value**



type **xsd:float**

source `<xsd:element name="value" type="xsd:float"/>`

element **eanucc:QuantityType/unitOfMeasure**

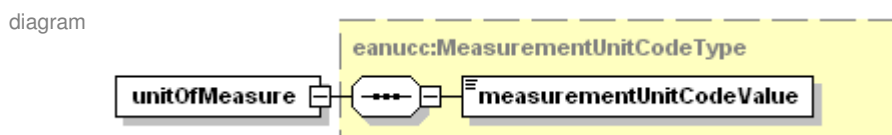

type [eanucc:MeasurementUnitCodeType](#)

children [measurementUnitCodeValue](#)

source `<xsd:element name="unitOfMeasure" type="eanucc:MeasurementUnitCodeType" minOccurs="0"/>`

complexType **eanucc:AdditionalTradeltemIdentificationType**

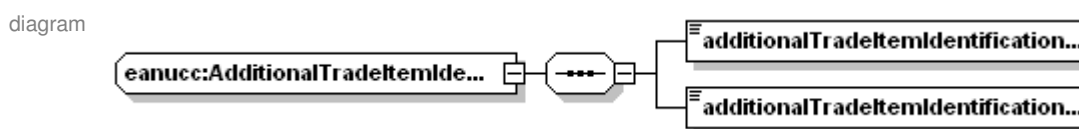

namespace urn:ean.ucc:2

children [additionalTradeltemIdentificationValue](#) [additionalTradeltemIdentificationType](#)

used by element [eanucc:TradeltemIdentificationType/additionalTradeltemIdentification](#)

source

```
<xsd:complexType name="AdditionalTradeltemIdentificationType">
  <xsd:sequence>
    <xsd:element name="additionalTradeltemIdentificationValue">
      <xsd:simpleType>
        <xsd:restriction base="xsd:string">
          <xsd:maxLength value="80"/>
          <xsd:minLength value="1"/>
        </xsd:restriction>
      </xsd:simpleType>
    </xsd:element>
    <xsd:element name="additionalTradeltemIdentificationType"
      type="eanucc:AdditionalTradeltemIdentificationListType"/>
  </xsd:sequence>
</xsd:complexType>
```

element **eanucc:AdditionalTradeltemIdentificationType/additionalTradeltemIdentificationValue**



type restriction of **xsd:string**

facets
minLength 1
maxLength 80

source

```
<xsd:element name="additionalTradeltemIdentificationValue">
  <xsd:simpleType>
    <xsd:restriction base="xsd:string">
      <xsd:maxLength value="80"/>
      <xsd:minLength value="1"/>
    </xsd:restriction>
  </xsd:simpleType>
</xsd:element>
```

element **eanucc:AdditionalTradeltemIdentificationType/**additionalTradeltemIdentificationType

diagram

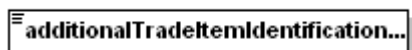

type [eanucc:AdditionalTradeltemIdentificationListType](#)

facets	enumeration	BUYER_ASSIGNED
	enumeration	FOR_INTERNAL_USE_1
	enumeration	FOR_INTERNAL_USE_2
	enumeration	FOR_INTERNAL_USE_3
	enumeration	FOR_INTERNAL_USE_4
	enumeration	FOR_INTERNAL_USE_5
	enumeration	FOR_INTERNAL_USE_6
	enumeration	FOR_INTERNAL_USE_7
	enumeration	FOR_INTERNAL_USE_8
	enumeration	FOR_INTERNAL_USE_9
	enumeration	FOR_INTERNAL_USE_10
	enumeration	FOR_INTERNAL_USE_11
	enumeration	FOR_INTERNAL_USE_12
	enumeration	FOR_INTERNAL_USE_13
	enumeration	FOR_INTERNAL_USE_14
	enumeration	FOR_INTERNAL_USE_15
	enumeration	FOR_INTERNAL_USE_16
	enumeration	FOR_INTERNAL_USE_17
	enumeration	FOR_INTERNAL_USE_18
	enumeration	FOR_INTERNAL_USE_19
	enumeration	FOR_INTERNAL_USE_20
	enumeration	INDUSTRY_ASSIGNED
	enumeration	SUPPLIER_ASSIGNED

source `<xsd:element name="additionalTradeltemIdentificationType" type="eanucc:AdditionalTradeltemIdentificationListType"/>`

complexType **eanucc:TradeltemIdentificationType**

diagram

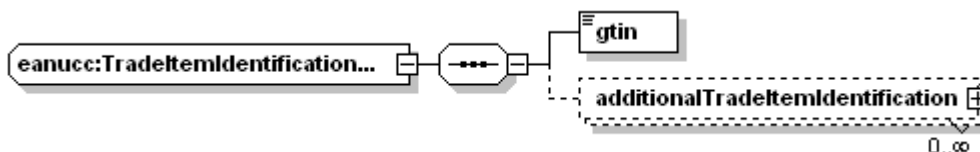

namespace urn:ean.ucc:2

children [gtin](#) [additionalTradeltemIdentification](#)

used by elements [deliver:ItemContainmentType/containedItemIdentification](#)
[deliver:ItemContainmentType/requestedItemIdentification](#)
[ConsignedItemWeightType/tradeltemIdentification](#)

source `<xsd:complexType name="TradeltemIdentificationType">
 <xsd:sequence>
 <xsd:element name="gtin" type="eanucc:GlobalTradeltemNumberType"/>
 <xsd:element name="additionalTradeltemIdentification" type="eanucc:AdditionalTradeltemIdentificationType"
 minOccurs="0" maxOccurs="unbounded"/>
 </xsd:sequence>
 </xsd:complexType>`

element **eanucc:TradeltemIdentificationType/**gtin

diagram

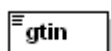

type [eanucc:GlobalTradeltemNumberType](#)

facets pattern \d{14}

source `<xsd:element name="gtin" type="eanucc:GlobalTradeltemNumberType"/>`

element **eanucc:TradeltemIdentificationType/additionalTradeltemIdentification**

diagram

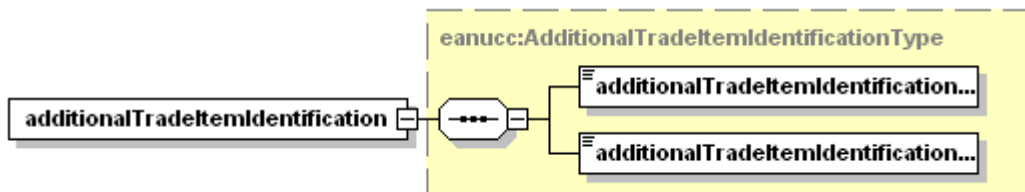

type [eanucc:AdditionalTradeltemIdentificationType](#)

children [additionalTradeltemIdentificationValue](#) [additionalTradeltemIdentificationType](#)

source

```
<xsd:element name="additionalTradeltemIdentification" type="eanucc:AdditionalTradeltemIdentificationType" minOccurs="0" maxOccurs="unbounded"/>
```

simpleType **eanucc:GlobalTradeltemNumberType**

namespace urn:ean.ucc:2

type restriction of **xsd:string**

used by element [eanucc:TradeltemIdentificationType/gtin](#)

facets pattern `\d{14}`

source

```
<xsd:simpleType name="GlobalTradeltemNumberType">
  <xsd:restriction base="xsd:string">
    <xsd:pattern value="\d{14}"/>
  </xsd:restriction>
</xsd:simpleType>
```

complexType **eanucc:UnitMeasurementType**

diagram

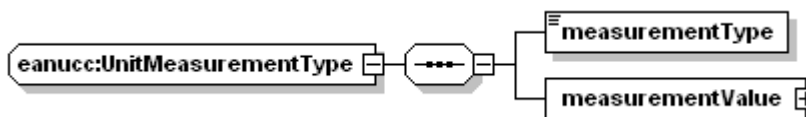

namespace urn:ean.ucc:2

children [measurementType](#) [measurementValue](#)

used by elements [eanucc:TransactionalItemDataType/transactionalItemWeight](#) [ConsignmentInformationType/unitMeasurement](#) [ConsignedItemWeightType/unitMeasurement](#) [deliver:LogisticUnitMeasurementType/unitMeasurement](#)

source

```
<xsd:complexType name="UnitMeasurementType">
  <xsd:sequence>
    <xsd:element name="measurementType" type="eanucc:MeasurementTypeCodeListType"/>
    <xsd:element name="measurementValue" type="eanucc:MeasurementValueType"/>
  </xsd:sequence>
</xsd:complexType>
```

element **eanucc:UnitMeasurementType/measurementType**

diagram

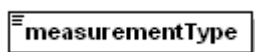

type [eanucc:MeasurementTypeCodeListType](#)

facets enumeration DECLARED_NET_WEIGHT
enumeration TARE_WEIGHT
enumeration TOTAL_GROSS_WEIGHT
enumeration UNIT_GROSS_WEIGHT
enumeration UNIT_NET_WEIGHT
enumeration GROSS_VOLUME
enumeration NET_VOLUME

source

```
<xsd:element name="measurementType" type="eanucc:MeasurementTypeCodeListType"/>
```

element eanucc:UnitMeasurementType/measurementValue

diagram

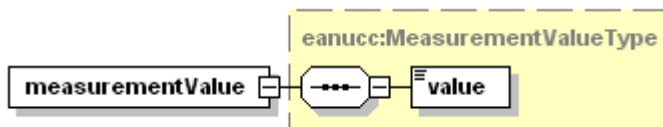

type [eanucc:MeasurementValueType](#)

children [value](#)

attributes	Name	Type	Use	Default	Fixed	Annotation
	unitOfMeasure	xsd:string	required			

source `<xsd:element name="measurementValue" type="eanucc:MeasurementValueType"/>`

complexType eanucc:ExtensionType

diagram

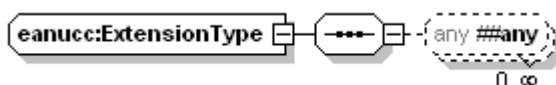

namespace urn:ean.ucc:2

used by elements [DespatchAdviceType/extension](#) [deliver:ItemContainmentType/extension](#)

source `<xsd:complexType name="ExtensionType">
 <xsd:sequence>
 <xsd:any namespace="##any" processContents="lax" minOccurs="0" maxOccurs="unbounded"/>
 </xsd:sequence>
 </xsd:complexType>`

complexType eanucc:DocumentReferenceType

diagram

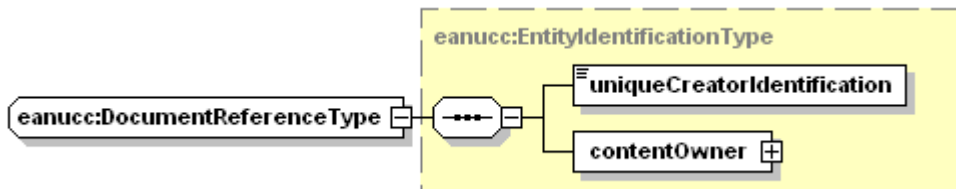

namespace urn:ean.ucc:2

type extension of [eanucc:EntityIdentificationType](#)

children [uniqueCreatorIdentification](#) [contentOwner](#)

used by elements [eanucc:DocumentOrDocumentLineReferenceType/documentReference](#)
[eanucc:DocumentLineReferenceType/documentReference](#)
[DespatchAdviceType/purchaseConditions](#)
[DespatchAdviceType/purchaseOrder](#)

attributes	Name	Type	Use	Default	Fixed	Annotation
	creationDateTim	xsd:dateTime				
	e					

source `<xsd:complexType name="DocumentReferenceType">
 <xsd:complexContent>
 <xsd:extension base="eanucc:EntityIdentificationType">
 <xsd:attribute name="creationDateTime" type="xsd:dateTime"/>
 </xsd:extension>
 </xsd:complexContent>
 </xsd:complexType>`

complexType **eanucc:AdditionalPartyIdentificationType**

diagram

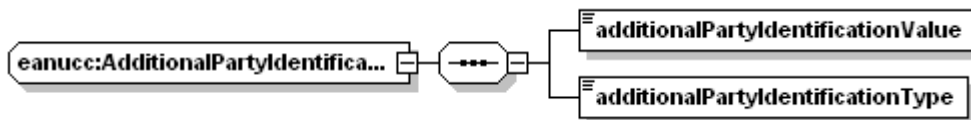

namespace urn:ean.ucc:2

children [additionalPartyIdentificationValue](#) [additionalPartyIdentificationType](#)

used by element [eanucc:PartyIdentificationType/additionalPartyIdentification](#)

```
<xsd:complexType name="AdditionalPartyIdentificationType">
  <xsd:sequence>
    <xsd:element name="additionalPartyIdentificationValue" type="xsd:string"/>
    <xsd:element name="additionalPartyIdentificationType" type="eanucc:AdditionalPartyIdentificationListType"/>
  </xsd:sequence>
</xsd:complexType>
```

element **eanucc:AdditionalPartyIdentificationType/additionalPartyIdentificationValue**

diagram

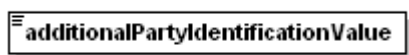

type **xsd:string**

```
<xsd:element name="additionalPartyIdentificationValue" type="xsd:string"/>
```

element **eanucc:AdditionalPartyIdentificationType/additionalPartyIdentificationType**

diagram

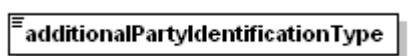

type [eanucc:AdditionalPartyIdentificationListType](#)

facets

enumeration	BUYER_ASSIGNED_IDENTIFIER_FOR_A_PARTY
enumeration	DEA_DRUG_ENFORCEMENT_AGENCY
enumeration	DUNS
enumeration	DUNS_PLUS_FOUR
enumeration	FOR_INTERNAL_USE_1
enumeration	FOR_INTERNAL_USE_2
enumeration	FOR_INTERNAL_USE_3
enumeration	FOR_INTERNAL_USE_4
enumeration	FOR_INTERNAL_USE_5
enumeration	FOR_INTERNAL_USE_6
enumeration	FOR_INTERNAL_USE_7
enumeration	FOR_INTERNAL_USE_8
enumeration	FOR_INTERNAL_USE_9
enumeration	FOR_INTERNAL_USE_10
enumeration	FOR_INTERNAL_USE_11
enumeration	FOR_INTERNAL_USE_12
enumeration	FOR_INTERNAL_USE_13
enumeration	FOR_INTERNAL_USE_14
enumeration	FOR_INTERNAL_USE_15
enumeration	FOR_INTERNAL_USE_16
enumeration	FOR_INTERNAL_USE_17
enumeration	FOR_INTERNAL_USE_18
enumeration	FOR_INTERNAL_USE_19
enumeration	FOR_INTERNAL_USE_20
enumeration	HIN_CANADIAN_HEALTHCARE_IDENTIFICATION_NUMBER
enumeration	SCAC
enumeration	SELLER_ASSIGNED_IDENTIFIER_FOR_A_PARTY
enumeration	TD_LINK_TRADE_DIMENSIONS
enumeration	UCC_COMMUNICATION_IDENTIFICATION
enumeration	UN_LOCATION_CODE
enumeration	USDA_ESTABLISHMENT_NUMBER

```
<xsd:element name="additionalPartyIdentificationType" type="eanucc:AdditionalPartyIdentificationListType"/>
```

complexType eanucc:PartyIdentificationType

diagram

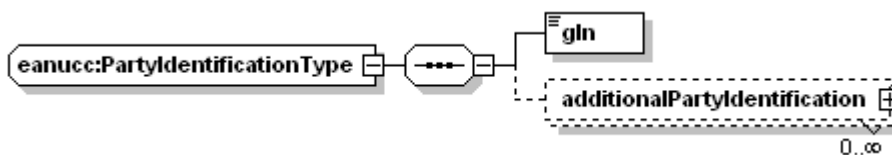

namespace urn:ean.ucc:2

children [gln](#) [additionalPartyIdentification](#)

used by elements [DespatchAdviceType/carrier](#) [eanucc:EntityIdentificationType/contentOwner](#)
[DespatchAdviceType/inventoryLocation](#)
[DespatchAdviceType/pickUpLocation](#) [DespatchAdviceType/receiver](#)
[DespatchAdviceType/shipFrom](#) [DespatchAdviceType/shipper](#)
[DespatchAdviceType/shipTo](#)

```
<xsd:complexType name="PartyIdentificationType">  
  <xsd:sequence>  
    <xsd:element name="gln" type="eanucc:GlobalLocationNumberType"/>  
    <xsd:element name="additionalPartyIdentification" type="eanucc:AdditionalPartyIdentificationType" minOccurs="0"  
      maxOccurs="unbounded"/>  
  </xsd:sequence>  
</xsd:complexType>
```

element eanucc:PartyIdentificationType/gln

diagram

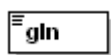

type [eanucc:GlobalLocationNumberType](#)

facets pattern \d{13}

```
<xsd:element name="gln" type="eanucc:GlobalLocationNumberType"/>
```

element eanucc:PartyIdentificationType/additionalPartyIdentification

diagram

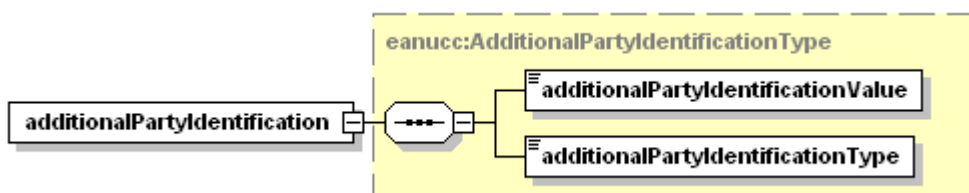

type [eanucc:AdditionalPartyIdentificationType](#)

children [additionalPartyIdentificationValue](#) [additionalPartyIdentificationType](#)

```
<xsd:element name="additionalPartyIdentification" type="eanucc:AdditionalPartyIdentificationType" minOccurs="0"  
  maxOccurs="unbounded"/>
```

simpleType eanucc:GlobalLocationNumberType

namespace urn:ean.ucc:2

type restriction of **xsd:string**

used by element [eanucc:PartyIdentificationType/gln](#)

facets pattern \d{13}

```
<xsd:simpleType name="GlobalLocationNumberType">  
  <xsd:restriction base="xsd:string">  
    <xsd:pattern value="\d{13}"/>  
  </xsd:restriction>  
</xsd:simpleType>
```

complexType eanucc:EntityIdentificationType

diagram

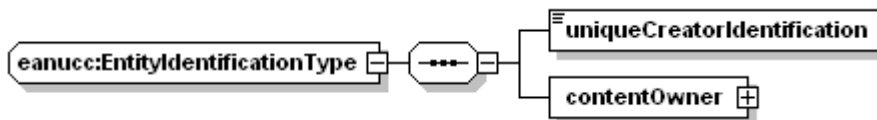

namespace urn:ean.ucc:2

children [uniqueCreatorIdentification](#) [contentOwner](#)

used by elements [DespatchAdviceType/despatchAdviceIdentification](#)
[eanucc:TypedEntityIdentificationType/entityIdentification](#)
[eanucc:ResponseType/responseIdentification](#)
 complexType [eanucc:DocumentReferenceType](#)

```
source <xsd:complexType name="EntityIdentificationType">
  <xsd:sequence>
    <xsd:element name="uniqueCreatorIdentification">
      <xsd:simpleType>
        <xsd:restriction base="xsd:string">
          <xsd:maxLength value="80"/>
          <xsd:minLength value="1"/>
        </xsd:restriction>
      </xsd:simpleType>
    </xsd:element>
    <xsd:element name="contentOwner" type="eanucc:PartyIdentificationType"/>
  </xsd:sequence>
</xsd:complexType>
```

element eanucc:EntityIdentificationType/uniqueCreatorIdentification

diagram

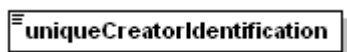

type restriction of **xsd:string**

facets
 minLength 1
 maxLength 80

```
source <xsd:element name="uniqueCreatorIdentification">
  <xsd:simpleType>
    <xsd:restriction base="xsd:string">
      <xsd:maxLength value="80"/>
      <xsd:minLength value="1"/>
    </xsd:restriction>
  </xsd:simpleType>
</xsd:element>
```

element eanucc:EntityIdentificationType/contentOwner

diagram

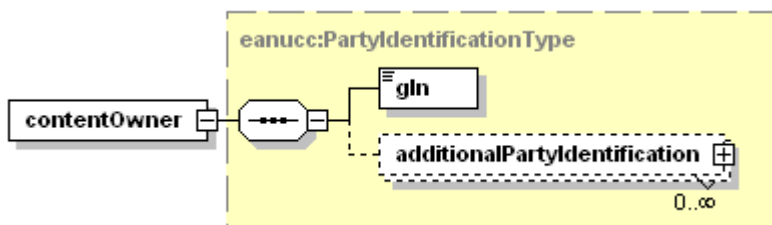

type [eanucc:PartyIdentificationType](#)

children [gln](#) [additionalPartyIdentification](#)

```
source <xsd:element name="contentOwner" type="eanucc:PartyIdentificationType"/>
```

complexType eanucc:TypedEntityIdentificationType

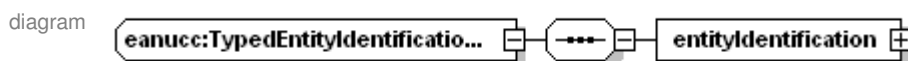

namespace urn:ean.ucc:2

children [entityIdentification](#)

attributes	Name	Type	Use	Default	Fixed	Annotation
	entityType	xsd:integer	required			

```

source <xsd:complexType name="TypedEntityIdentificationType">
  <xsd:sequence>
    <xsd:element name="entityIdentification" type="eanucc:EntityIdentificationType"/>
  </xsd:sequence>
  <xsd:attribute name="entityType" use="required">
    <xsd:simpleType>
      <xsd:restriction base="xsd:integer">
        <xsd:totalDigits value="4"/>
      </xsd:restriction>
    </xsd:simpleType>
  </xsd:attribute>
</xsd:complexType>

```

element eanucc:TypedEntityIdentificationType/entityIdentification

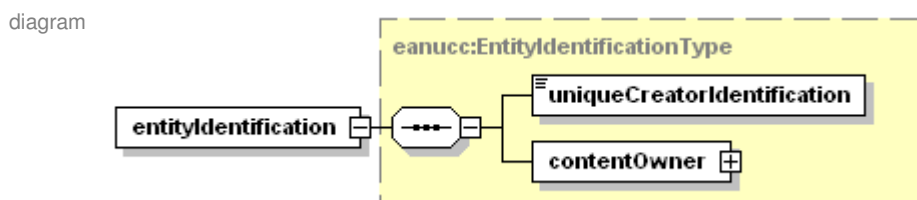

type [eanucc:EntityIdentificationType](#)

children [uniqueCreatorIdentification](#) [contentOwner](#)

```

source <xsd:element name="entityIdentification" type="eanucc:EntityIdentificationType"/>

```

element eanucc:document

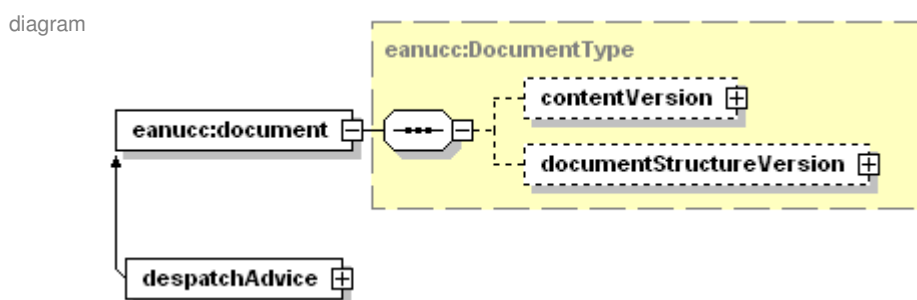

namespace urn:ean.ucc:2

type [eanucc:DocumentType](#)

children [contentVersion](#) [documentStructureVersion](#)

attributes	Name	Type	Use	Default	Fixed	Annotation
	lastUpdateDate	xsd:date				
	creationDateTim	xsd:dateTime	required			
	documentStatus	eanucc:Docume ntStatusList Type	required			

```

source <xsd:element name="document" type="eanucc:DocumentType" abstract="true"/>

```

element eanucc:response

diagram

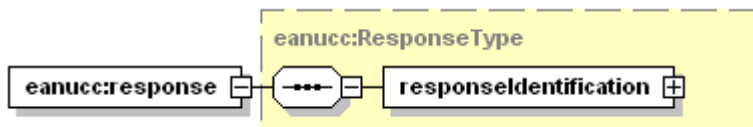

namespace urn:ean.ucc:2

type [eanucc:ResponseType](#)

children [responseIdentification](#)

attributes	Name	Type	Use	Default	Fixed	Annotation
	responseStatus	eanucc:ResponseStatusListType	required			

source `<xsd:element name="response" type="eanucc:ResponseType" abstract="true"/>`

complexType eanucc:DetailLevelReferenceType

diagram

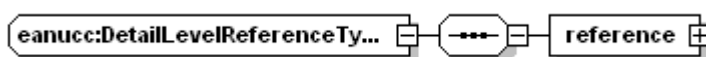

namespace urn:ean.ucc:2

type extension of [eanucc:LineItemType](#)

children [reference](#)

used by elements [deliver:ItemContainmentType/consignment](#) [deliver:ItemContainmentType/contract](#)
[deliver:ItemContainmentType/customer](#)
[deliver:ItemContainmentType/deliveryNote](#)
[deliver:ItemContainmentType/productCertification](#)
[deliver:ItemContainmentType/promotionalDeal](#)
[deliver:ItemContainmentType/specification](#)

attributes	Name	Type	Use	Default	Fixed	Annotation
	number	xsd:nonNegativeInteger	required			

source `<xsd:complexType name="DetailLevelReferenceType">
 <xsd:complexContent>
 <xsd:extension base="eanucc:LineItemType">
 <xsd:sequence>
 <xsd:element name="reference" type="eanucc:ReferenceType"/>
 </xsd:sequence>
 </xsd:extension>
 </xsd:complexContent>
 </xsd:complexType>`

element eanucc:DetailLevelReferenceType/reference

diagram

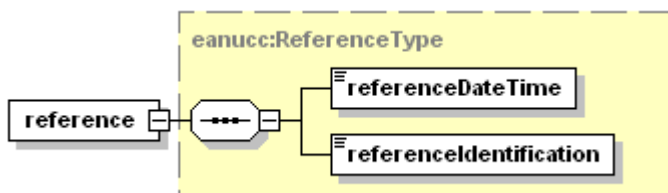

type [eanucc:ReferenceType](#)

children [referenceDateTime](#) [referenceIdentification](#)

source `<xsd:element name="reference" type="eanucc:ReferenceType"/>`

complexType eanucc:DocumentType

diagram

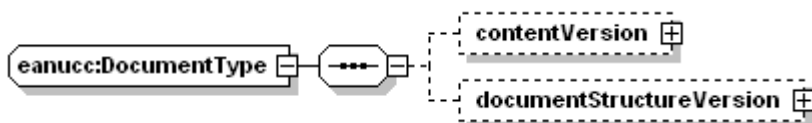

namespace urn:ean.ucc:2

children [contentVersion](#) [documentStructureVersion](#)

used by element [eanucc:document](#)
complexType [DespatchAdviceType](#)

attributes	Name	Type	Use	Default	Fixed	Annotation
	lastUpdateDate	xsd:date				
	creationDateTim	xsd:dateTime	required			
	documentStatus	eanucc:Docume ntStatusListType	required			

```

source <xsd:complexType name="DocumentType" abstract="true">
  <xsd:sequence>
    <xsd:element name="contentVersion" type="eanucc:VersionType" minOccurs="0"/>
    <xsd:element name="documentStructureVersion" type="eanucc:VersionType" minOccurs="0"/>
  </xsd:sequence>
  <xsd:attribute name="lastUpdateDate" type="xsd:date"/>
  <xsd:attribute name="creationDateTim" type="xsd:dateTime" use="required"/>
  <xsd:attribute name="documentStatus" type="eanucc:DocumentStatusListType" use="required"/>
</xsd:complexType>

```

element eanucc:DocumentType/contentVersion

diagram

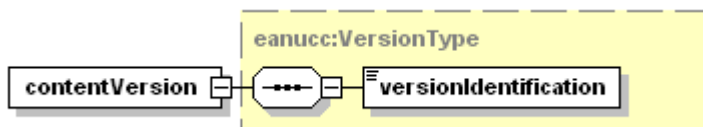

type [eanucc:VersionType](#)

children [versionIdentification](#)

```

source <xsd:element name="contentVersion" type="eanucc:VersionType" minOccurs="0"/>

```

element eanucc:DocumentType/documentStructureVersion

diagram

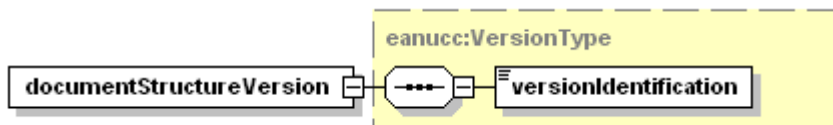

type [eanucc:VersionType](#)

children [versionIdentification](#)

```

source <xsd:element name="documentStructureVersion" type="eanucc:VersionType" minOccurs="0"/>

```

complexType eanucc:LineItemType

diagram



namespace urn:ean.ucc:2

used by complexTypes [deliver:ItemContainmentType](#) [eanucc:DetailLevelReferenceType](#)
[eanucc:DocumentLineReferenceType](#)

attributes	Name	Type	Use	Default	Fixed	Annotation
	number	xsd:nonNegative Integer	required			

```

source <xsd:complexType name="LineItemType" abstract="true">
  <xsd:attribute name="number" use="required">
    <xsd:simpleType>
      <xsd:restriction base="xsd:nonNegativeInteger">
        <xsd:totalDigits value="6"/>
      </xsd:restriction>
    </xsd:simpleType>
  </xsd:attribute>
</xsd:complexType>

```

complexType eanucc:ReferenceType

diagram

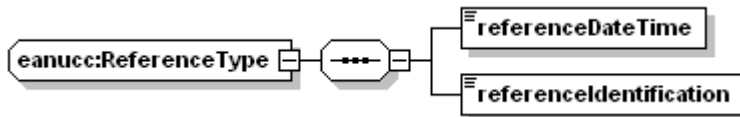

namespace urn:ean.ucc:2

children [referenceDateTime](#) [referenceIdentification](#)

used by elements [DeliveryAndTransportInformationType/billOfLadingNumber](#)
[ConsignmentInformationType/consignmentIdentification](#)
[DespatchAdviceType/contract](#)
[DespatchAdviceType/declarantsCustomsIdentity](#)
[DespatchAdviceType/deliveryNote](#)
[DespatchAdviceType/productCertification](#)
[eanucc:DetailLevelReferenceType/reference](#)
[DespatchAdviceType/specification](#)

```

source <xsd:complexType name="ReferenceType">
  <xsd:sequence>
    <xsd:element name="referenceDateTime" type="xsd:dateTime"/>
    <xsd:element name="referenceIdentification">
      <xsd:simpleType>
        <xsd:restriction base="xsd:string">
          <xsd:maxLength value="80"/>
          <xsd:minLength value="1"/>
        </xsd:restriction>
      </xsd:simpleType>
    </xsd:element>
  </xsd:sequence>
</xsd:complexType>

```

element eanucc:ReferenceType/referenceDateTime

diagram

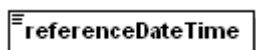

type **xsd:dateTime**

source <xsd:element name="referenceDateTime" type="xsd:dateTime"/>

element eanucc:ReferenceType/referenceIdentification

diagram

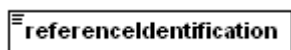

type restriction of **xsd:string**

facets
 minLength 1
 maxLength 80

```

source <xsd:element name="referenceIdentification">
  <xsd:simpleType>
    <xsd:restriction base="xsd:string">
      <xsd:maxLength value="80"/>
      <xsd:minLength value="1"/>
    </xsd:restriction>
  </xsd:simpleType>
</xsd:element>

```

complexType eanucc:ResponseType

diagram



namespace urn:ean.ucc:2

children [responseIdentification](#)

used by element [eanucc:response](#)

attributes	Name	Type	Use	Default	Fixed	Annotation
	responseStatus	eanucc:ResponseStatusListType	required			

```
<xsd:complexType name="ResponseType" abstract="true">
  <xsd:sequence>
    <xsd:element name="responseIdentification" type="eanucc:EntityIdentificationType"/>
  </xsd:sequence>
  <xsd:attribute name="responseStatus" type="eanucc:ResponseStatusListType" use="required"/>
</xsd:complexType>
```

element eanucc:ResponseType/responseIdentification

diagram

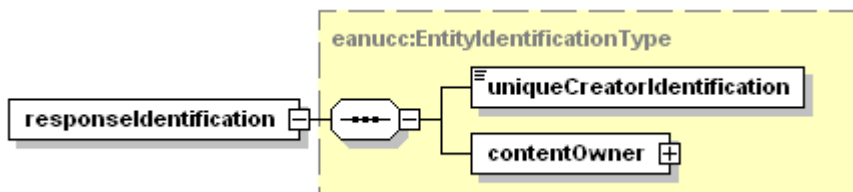

type [eanucc:EntityIdentificationType](#)

children [uniqueCreatorIdentification](#) [contentOwner](#)

```
<xsd:element name="responseIdentification" type="eanucc:EntityIdentificationType"/>
```

complexType eanucc:VersionType

diagram



namespace urn:ean.ucc:2

children [versionIdentification](#)

used by elements [eanucc:DocumentType/contentVersion](#) [eanucc:DocumentType/documentStructureVersion](#)

```
<xsd:complexType name="VersionType">
  <xsd:sequence>
    <xsd:element name="versionIdentification" type="xsd:string"/>
  </xsd:sequence>
</xsd:complexType>
```

element eanucc:VersionType/versionIdentification

diagram

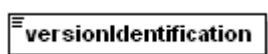

type `xsd:string`

```
<xsd:element name="versionIdentification" type="xsd:string"/>
```

complexType deliver:LogisticUnitMeasurementType

diagram

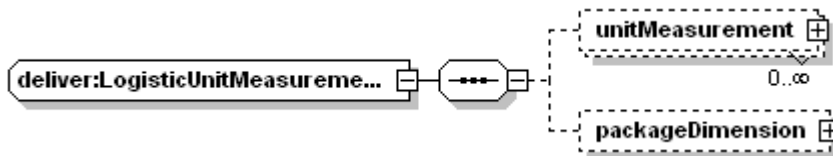

namespace urn:ean.ucc:deliver:2

children [unitMeasurement](#) [packageDimension](#)

used by element [deliver:LogisticUnitsType/logisticUnitMeasurement](#)

```
<xsd:complexType name="LogisticUnitMeasurementType">
  <xsd:sequence>
    <xsd:element name="unitMeasurement" type="eanucc:UnitMeasurementType" minOccurs="0"
      maxOccurs="unbounded"/>
    <xsd:element name="packageDimension" type="deliver:PackageDimensionType" minOccurs="0"/>
  </xsd:sequence>
</xsd:complexType>
```

element deliver:LogisticUnitMeasurementType/unitMeasurement

diagram

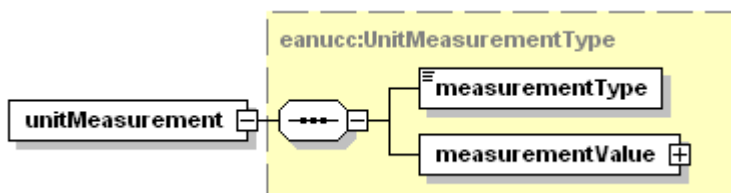

type [eanucc:UnitMeasurementType](#)

children [measurementType](#) [measurementValue](#)

```
<xsd:element name="unitMeasurement" type="eanucc:UnitMeasurementType" minOccurs="0"
  maxOccurs="unbounded"/>
```

element deliver:LogisticUnitMeasurementType/packageDimension

diagram

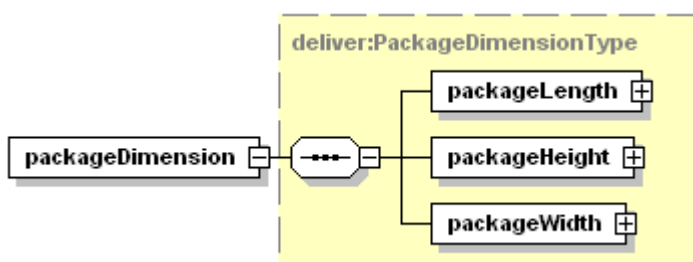

type [deliver:PackageDimensionType](#)

children [packageLength](#) [packageHeight](#) [packageWidth](#)

```
<xsd:element name="packageDimension" type="deliver:PackageDimensionType" minOccurs="0"/>
```

complexType eanucc:LogisticUnitIdentificationType

diagram

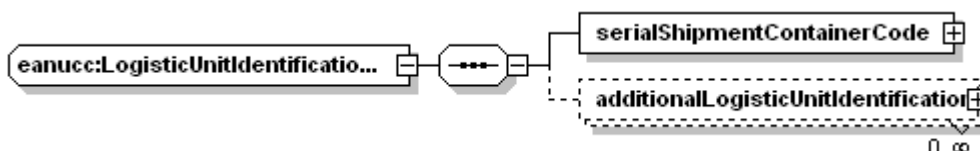

namespace urn:ean.ucc:2

children [serialShipmentContainerCode](#) [additionalLogisticUnitIdentification](#)

used by element [deliver:LogisticUnitsType/logisticUnitIdentification](#)

```
source <xsd:complexType name="LogisticUnitIdentificationType">
  <xsd:sequence>
    <xsd:element name="serialShipmentContainerCode" type="eanucc:SSCCType"/>
    <xsd:element name="additionalLogisticUnitIdentification" type="eanucc:AdditionalLogisticUnitIdentificationType"
      minOccurs="0" maxOccurs="unbounded"/>
  </xsd:sequence>
</xsd:complexType>
```

element eanucc:LogisticUnitIdentificationType/serialShipmentContainerCode

diagram

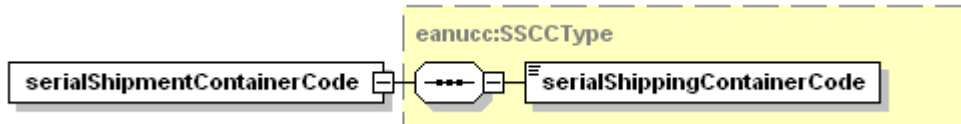

type [eanucc:SSCCType](#)

children [serialShippingContainerCode](#)

```
source <xsd:element name="serialShipmentContainerCode" type="eanucc:SSCCType"/>
```

element eanucc:LogisticUnitIdentificationType/additionalLogisticUnitIdentification

diagram

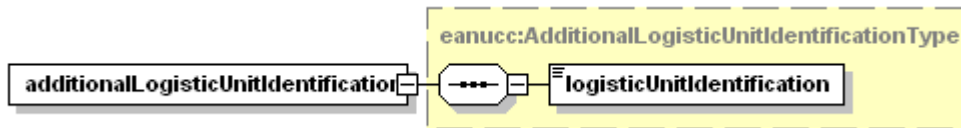

type [eanucc:AdditionalLogisticUnitIdentificationType](#)

children [logisticUnitIdentification](#)

```
source <xsd:element name="additionalLogisticUnitIdentification" type="eanucc:AdditionalLogisticUnitIdentificationType"
  minOccurs="0" maxOccurs="unbounded"/>
```

complexType eanucc:TransactionalItemDataType

diagram



namespace urn:ean.ucc:2

children [availableForSaleDate](#) [batchNumber](#) [bestBeforeDate](#) [countryOfOrigin](#) [itemExpirationDate](#) [lotNumber](#) [packagingDate](#) [productionDate](#) [productQualityIndication](#) [sellByDate](#) [shelfLife](#) [transactionalItemWeight](#)

used by element [deliver:ItemContainmentType/extendedAttributes](#)

```
<xsd:complexType name="TransactionalItemDataType">
  <xsd:sequence>
    <xsd:element name="availableForSaleDate" type="xsd:date" minOccurs="0"/>
    <xsd:element name="batchNumber" type="xsd:string" minOccurs="0"/>
    <xsd:element name="bestBeforeDate" type="xsd:date" minOccurs="0"/>
    <xsd:element name="countryOfOrigin" type="eanucc:ISO3166_1CodeType" minOccurs="0"/>
    <xsd:element name="itemExpirationDate" type="xsd:date" minOccurs="0"/>
    <xsd:element name="lotNumber" type="xsd:string" minOccurs="0"/>
    <xsd:element name="packagingDate" type="xsd:date" minOccurs="0"/>
    <xsd:element name="productionDate" type="xsd:date" minOccurs="0"/>
    <xsd:element name="productQualityIndication" type="eanucc:QuantityType" minOccurs="0"/>
    <xsd:element name="sellByDate" type="xsd:date" minOccurs="0"/>
    <xsd:element name="shelfLife" type="xsd:string" minOccurs="0"/>
    <xsd:element name="transactionalItemWeight" type="eanucc:UnitMeasurementType" minOccurs="0"
maxOccurs="unbounded"/>
  </xsd:sequence>
</xsd:complexType>
```

element eanucc:TransactionalItemDataType/availableForSaleDate

diagram

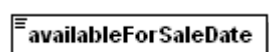

type xsd:date

source <xsd:element name="availableForSaleDate" type="xsd:date" minOccurs="0"/>

element **eanucc:TransactionalItemType/batchNumber**



type **xsd:string**

source `<xsd:element name="batchNumber" type="xsd:string" minOccurs="0"/>`

element **eanucc:TransactionalItemType/bestBeforeDate**



type **xsd:date**

source `<xsd:element name="bestBeforeDate" type="xsd:date" minOccurs="0"/>`

element **eanucc:TransactionalItemType/countryOfOrigin**

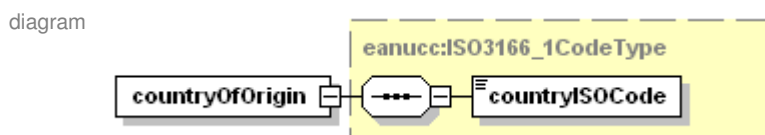

type [eanucc:ISO3166_1CodeType](#)

children [countryISOCode](#)

source `<xsd:element name="countryOfOrigin" type="eanucc:ISO3166_1CodeType" minOccurs="0"/>`

element **eanucc:TransactionalItemType/itemExpirationDate**

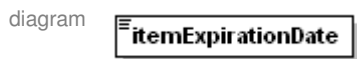

type **xsd:date**

source `<xsd:element name="itemExpirationDate" type="xsd:date" minOccurs="0"/>`

element **eanucc:TransactionalItemType/lotNumber**



type **xsd:string**

source `<xsd:element name="lotNumber" type="xsd:string" minOccurs="0"/>`

element **eanucc:TransactionalItemType/packagingDate**

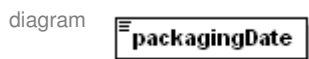

type **xsd:date**

source `<xsd:element name="packagingDate" type="xsd:date" minOccurs="0"/>`

element **eanucc:TransactionalItemType/productionDate**

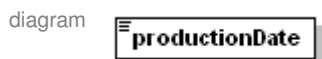

type **xsd:date**

source `<xsd:element name="productionDate" type="xsd:date" minOccurs="0"/>`

element **eanucc:TransactionalItemDataType/productQualityIndication**

diagram

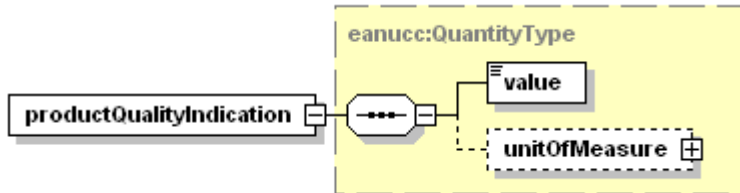

type [eanucc:QuantityType](#)

children [value](#) [unitOfMeasure](#)

source `<xsd:element name="productQualityIndication" type="eanucc:QuantityType" minOccurs="0"/>`

element **eanucc:TransactionalItemDataType/sellByDate**

diagram

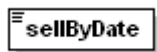

type **xsd:date**

source `<xsd:element name="sellByDate" type="xsd:date" minOccurs="0"/>`

element **eanucc:TransactionalItemDataType/shelfLife**

diagram



type **xsd:string**

source `<xsd:element name="shelfLife" type="xsd:string" minOccurs="0"/>`

element **eanucc:TransactionalItemDataType/transactionalItemWeight**

diagram

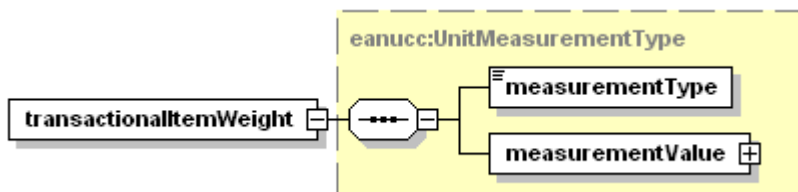

type [eanucc:UnitMeasurementType](#)

children [measurementType](#) [measurementValue](#)

source `<xsd:element name="transactionalItemWeight" type="eanucc:UnitMeasurementType" minOccurs="0" maxOccurs="unbounded"/>`

complexType **eanucc:DocumentOrDocumentLineReferenceType**

diagram

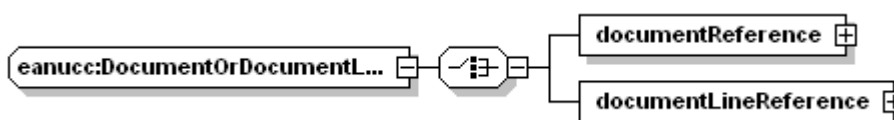

namespace `urn:ean.ucc:2`

children [documentReference](#) [documentLineReference](#)

used by elements [deliver:ItemContainmentType/purchaseConditions](#) [deliver:ItemContainmentType/purchaseOrder](#)

```
<xsd:complexType name="DocumentOrDocumentLineReferenceType">
  <xsd:choice>
    <xsd:element name="documentReference" type="eanucc:DocumentReferenceType"/>
    <xsd:element name="documentLineReference" type="eanucc:DocumentLineReferenceType"/>
  </xsd:choice>
</xsd:complexType>
```

element **eanucc:DocumentOrDocumentLineReferenceType/documentReference**

diagram

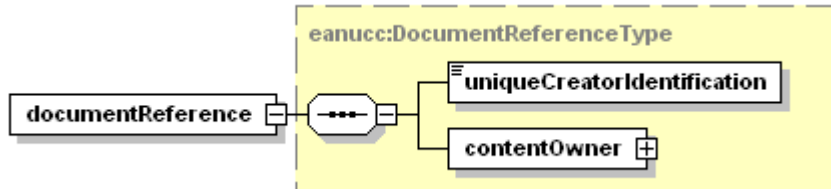

type [eanucc:DocumentReferenceType](#)

children [uniqueCreatorIdentification](#) [contentOwner](#)

attributes	Name	Type	Use	Default	Fixed	Annotation
	creationDateTim	xsd:dateTime				
	e					

```
<xsd:element name="documentReference" type="eanucc:DocumentReferenceType"/>
```

element **eanucc:DocumentOrDocumentLineReferenceType/documentLineReference**

diagram

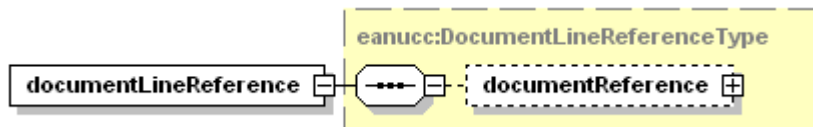

type [eanucc:DocumentLineReferenceType](#)

children [documentReference](#)

attributes	Name	Type	Use	Default	Fixed	Annotation
	number	xsd:nonNegativeInteger	required			

```
<xsd:element name="documentLineReference" type="eanucc:DocumentLineReferenceType"/>
```

complexType **eanucc:DateTimePeriodType**

diagram

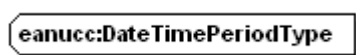

namespace urn:ean.ucc:2

used by element [eanucc:TimeOrDateTimePeriodType/dateTimePeriod](#)

attributes	Name	Type	Use	Default	Fixed	Annotation
	beginDateTime	xsd:dateTime	required			
	endDateTime	xsd:dateTime	required			

```
<xsd:complexType name="DateTimePeriodType">
  <xsd:attribute name="beginDateTime" type="xsd:dateTime" use="required"/>
  <xsd:attribute name="endDateTime" type="xsd:dateTime" use="required"/>
</xsd:complexType>
```

complexType **eanucc:TimePeriodType**

diagram

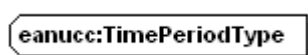

namespace urn:ean.ucc:2

used by element [eanucc:TimeOrDateTimePeriodType/timePeriod](#)

attributes	Name	Type	Use	Default	Fixed	Annotation
	beginDate	xsd:date	required			
	endDate	xsd:date	required			

source

```
<xsd:complexType name="TimePeriodType">
  <xsd:attribute name="beginDate" type="xsd:date" use="required"/>
  <xsd:attribute name="endDate" type="xsd:date" use="required"/>
</xsd:complexType>
```

complexType eanucc:MeasurementUnitCodeType

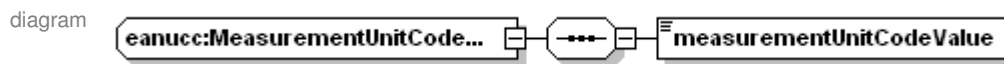

namespace urn:ean.ucc:2

children [measurementUnitCodeValue](#)

used by element [eanucc:QuantityType/unitOfMeasure](#)

source

```
<xsd:complexType name="MeasurementUnitCodeType">
  <xsd:sequence>
    <xsd:element name="measurementUnitCodeValue">
      <xsd:simpleType>
        <xsd:restriction base="xsd:string">
          <xsd:maxLength value="3"/>
          <xsd:minLength value="1"/>
        </xsd:restriction>
      </xsd:simpleType>
    </xsd:element>
  </xsd:sequence>
</xsd:complexType>
```

element eanucc:MeasurementUnitCodeType/measurementUnitCodeValue

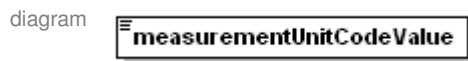

type restriction of **xsd:string**

facets
minLength 1
maxLength 3

source

```
<xsd:element name="measurementUnitCodeValue">
  <xsd:simpleType>
    <xsd:restriction base="xsd:string">
      <xsd:maxLength value="3"/>
      <xsd:minLength value="1"/>
    </xsd:restriction>
  </xsd:simpleType>
</xsd:element>
```

simpleType eanucc:AdditionalTradeltemIdentificationListType

namespace urn:ean.ucc:2

type restriction of **xsd:string**

used by element [eanucc:AdditionalTradeltemIdentificationType/additionalTradeltemIdentificationType](#)

facets

enumeration	BUYER_ASSIGNED
enumeration	FOR_INTERNAL_USE_1
enumeration	FOR_INTERNAL_USE_2
enumeration	FOR_INTERNAL_USE_3
enumeration	FOR_INTERNAL_USE_4
enumeration	FOR_INTERNAL_USE_5
enumeration	FOR_INTERNAL_USE_6
enumeration	FOR_INTERNAL_USE_7
enumeration	FOR_INTERNAL_USE_8
enumeration	FOR_INTERNAL_USE_9
enumeration	FOR_INTERNAL_USE_10
enumeration	FOR_INTERNAL_USE_11
enumeration	FOR_INTERNAL_USE_12

```

enumeration FOR_INTERNAL_USE_13
enumeration FOR_INTERNAL_USE_14
enumeration FOR_INTERNAL_USE_15
enumeration FOR_INTERNAL_USE_16
enumeration FOR_INTERNAL_USE_17
enumeration FOR_INTERNAL_USE_18
enumeration FOR_INTERNAL_USE_19
enumeration FOR_INTERNAL_USE_20
enumeration INDUSTRY_ASSIGNED
enumeration SUPPLIER_ASSIGNED

```

```

source <xsd:simpleType name="AdditionalTradeltemIdentificationListType">
  <xsd:restriction base="xsd:string">
    <xsd:enumeration value="BUYER_ASSIGNED"/>
    <xsd:enumeration value="FOR_INTERNAL_USE_1"/>
    <xsd:enumeration value="FOR_INTERNAL_USE_2"/>
    <xsd:enumeration value="FOR_INTERNAL_USE_3"/>
    <xsd:enumeration value="FOR_INTERNAL_USE_4"/>
    <xsd:enumeration value="FOR_INTERNAL_USE_5"/>
    <xsd:enumeration value="FOR_INTERNAL_USE_6"/>
    <xsd:enumeration value="FOR_INTERNAL_USE_7"/>
    <xsd:enumeration value="FOR_INTERNAL_USE_8"/>
    <xsd:enumeration value="FOR_INTERNAL_USE_9"/>
    <xsd:enumeration value="FOR_INTERNAL_USE_10"/>
    <xsd:enumeration value="FOR_INTERNAL_USE_11"/>
    <xsd:enumeration value="FOR_INTERNAL_USE_12"/>
    <xsd:enumeration value="FOR_INTERNAL_USE_13"/>
    <xsd:enumeration value="FOR_INTERNAL_USE_14"/>
    <xsd:enumeration value="FOR_INTERNAL_USE_15"/>
    <xsd:enumeration value="FOR_INTERNAL_USE_16"/>
    <xsd:enumeration value="FOR_INTERNAL_USE_17"/>
    <xsd:enumeration value="FOR_INTERNAL_USE_18"/>
    <xsd:enumeration value="FOR_INTERNAL_USE_19"/>
    <xsd:enumeration value="FOR_INTERNAL_USE_20"/>
    <xsd:enumeration value="INDUSTRY_ASSIGNED"/>
    <xsd:enumeration value="SUPPLIER_ASSIGNED"/>
  </xsd:restriction>
</xsd:simpleType>

```

complexType eanucc:MeasurementType

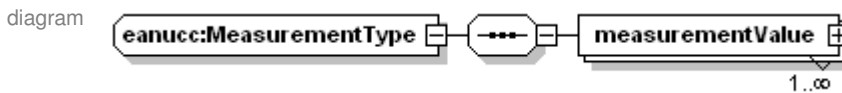

namespace urn:ean.ucc:2

children [measurementValue](#)

```

source <xsd:complexType name="MeasurementType">
  <xsd:sequence>
    <xsd:element name="measurementValue" type="eanucc:MeasurementValueType" maxOccurs="unbounded"/>
  </xsd:sequence>
</xsd:complexType>

```

element eanucc:MeasurementType/measurementValue

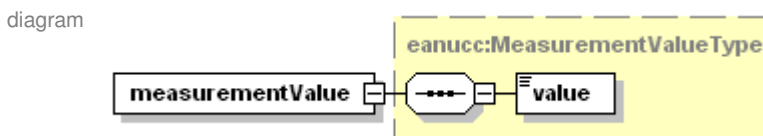

type [eanucc:MeasurementValueType](#)

children [value](#)

attributes	Name	Type	Use	Default	Fixed	Annotation
	unitOfMeasure	xsd:string	required			

```

source <xsd:element name="measurementValue" type="eanucc:MeasurementValueType" maxOccurs="unbounded"/>

```

complexType eanucc:MeasurementValueType

diagram

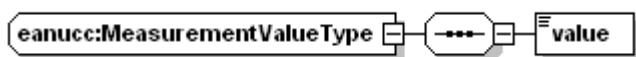

namespace urn:ean.ucc:2

children [value](#)

used by elements [eanucc:UnitMeasurementType/measurementValue](#)
[eanucc:MultiMeasurementValueType/measurementValue](#)
[eanucc:MeasurementType/measurementValue](#)

attributes	Name	Type	Use	Default	Fixed	Annotation
	unitOfMeasure	xsd:string	required			

```
<xsd:complexType name="MeasurementValueType">
  <xsd:sequence>
    <xsd:element name="value">
      <xsd:simpleType>
        <xsd:restriction base="xsd:decimal">
          <xsd:totalDigits value="15"/>
        </xsd:restriction>
      </xsd:simpleType>
    </xsd:element>
  </xsd:sequence>
  <xsd:attribute name="unitOfMeasure" use="required">
    <xsd:simpleType>
      <xsd:restriction base="xsd:string">
        <xsd:maxLength value="3"/>
        <xsd:minLength value="0"/>
      </xsd:restriction>
    </xsd:simpleType>
  </xsd:attribute>
</xsd:complexType>
```

element eanucc:MeasurementValueType/value

diagram

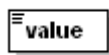

type restriction of **xsd:decimal**

facets totalDigits 15

```
<xsd:element name="value">
  <xsd:simpleType>
    <xsd:restriction base="xsd:decimal">
      <xsd:totalDigits value="15"/>
    </xsd:restriction>
  </xsd:simpleType>
</xsd:element>
```

complexType eanucc:MultiMeasurementValueType

diagram

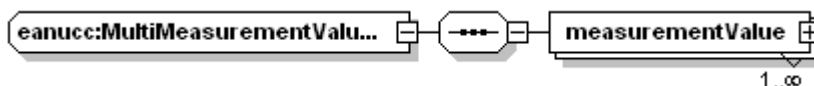

namespace urn:ean.ucc:2

children [measurementValue](#)

used by elements [deliver:PackageDimensionType/packageHeight](#) [deliver:PackageDimensionType/packageLength](#)
[deliver:PackageDimensionType/packageWidth](#)

```
<xsd:complexType name="MultiMeasurementValueType">
  <xsd:sequence>
    <xsd:element name="measurementValue" type="eanucc:MeasurementValueType" maxOccurs="unbounded"/>
  </xsd:sequence>
</xsd:complexType>
```

element **eanucc:MultiMeasurementValueType/measurementValue**

diagram

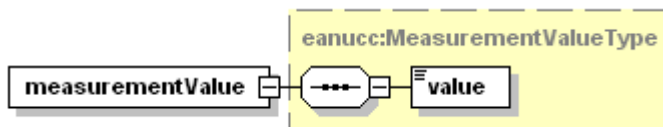

type [eanucc:MeasurementValueType](#)

children [value](#)

attributes	Name	Type	Use	Default	Fixed	Annotation
	unitOfMeasure	xsd:string	required			

source `<xsd:element name="measurementValue" type="eanucc:MeasurementValueType" maxOccurs="unbounded"/>`

simpleType **eanucc:MeasurementTypeCodeListType**

namespace urn:ean.ucc:2

type restriction of **xsd:string**

used by element [eanucc:UnitMeasurementType/measurementType](#)

facets

enumeration	DECLARED_NET_WEIGHT
enumeration	TARE_WEIGHT
enumeration	TOTAL_GROSS_WEIGHT
enumeration	UNIT_GROSS_WEIGHT
enumeration	UNIT_NET_WEIGHT
enumeration	GROSS_VOLUME
enumeration	NET_VOLUME

source `<xsd:simpleType name="MeasurementTypeCodeListType">
<xsd:restriction base="xsd:string">
<xsd:enumeration value="DECLARED_NET_WEIGHT"/>
<xsd:enumeration value="TARE_WEIGHT"/>
<xsd:enumeration value="TOTAL_GROSS_WEIGHT"/>
<xsd:enumeration value="UNIT_GROSS_WEIGHT"/>
<xsd:enumeration value="UNIT_NET_WEIGHT"/>
<xsd:enumeration value="GROSS_VOLUME"/>
<xsd:enumeration value="NET_VOLUME"/>
</xsd:restriction>
</xsd:simpleType>`

simpleType **eanucc:AdditionalPartyIdentificationListType**

namespace urn:ean.ucc:2

type restriction of **xsd:string**

used by element [eanucc:AdditionalPartyIdentificationType/additionalPartyIdentificationType](#)

facets

enumeration	BUYER_ASSIGNED_IDENTIFIER_FOR_A_PARTY
enumeration	DEA_DRUG_ENFORCEMENT_AGENCY
enumeration	DUNS
enumeration	DUNS_PLUS_FOUR
enumeration	FOR_INTERNAL_USE_1
enumeration	FOR_INTERNAL_USE_2
enumeration	FOR_INTERNAL_USE_3
enumeration	FOR_INTERNAL_USE_4
enumeration	FOR_INTERNAL_USE_5
enumeration	FOR_INTERNAL_USE_6
enumeration	FOR_INTERNAL_USE_7
enumeration	FOR_INTERNAL_USE_8
enumeration	FOR_INTERNAL_USE_9
enumeration	FOR_INTERNAL_USE_10
enumeration	FOR_INTERNAL_USE_11
enumeration	FOR_INTERNAL_USE_12
enumeration	FOR_INTERNAL_USE_13
enumeration	FOR_INTERNAL_USE_14
enumeration	FOR_INTERNAL_USE_15
enumeration	FOR_INTERNAL_USE_16
enumeration	FOR_INTERNAL_USE_17
enumeration	FOR_INTERNAL_USE_18

```

enumeration FOR_INTERNAL_USE_19
enumeration FOR_INTERNAL_USE_20
enumeration HIN_CANADIAN_HEALTHCARE_IDENTIFICATION_NUMBER
enumeration SCAC
enumeration SELLER_ASSIGNED_IDENTIFIER_FOR_A_PARTY
enumeration TD_LINK_TRADE_DIMENSIONS
enumeration UCC_COMMUNICATION_IDENTIFICATION
enumeration UN_LOCATION_CODE
enumeration USDA_ESTABLISHMENT_NUMBER
source <xsd:simpleType name="AdditionalPartyIdentificationListType">
  <xsd:restriction base="xsd:string">
    <xsd:enumeration value="BUYER_ASSIGNED_IDENTIFIER_FOR_A_PARTY"/>
    <xsd:enumeration value="DEA_DRUG_ENFORCEMENT_AGENCY"/>
    <xsd:enumeration value="DUNS"/>
    <xsd:enumeration value="DUNS_PLUS_FOUR"/>
    <xsd:enumeration value="FOR_INTERNAL_USE_1"/>
    <xsd:enumeration value="FOR_INTERNAL_USE_2"/>
    <xsd:enumeration value="FOR_INTERNAL_USE_3"/>
    <xsd:enumeration value="FOR_INTERNAL_USE_4"/>
    <xsd:enumeration value="FOR_INTERNAL_USE_5"/>
    <xsd:enumeration value="FOR_INTERNAL_USE_6"/>
    <xsd:enumeration value="FOR_INTERNAL_USE_7"/>
    <xsd:enumeration value="FOR_INTERNAL_USE_8"/>
    <xsd:enumeration value="FOR_INTERNAL_USE_9"/>
    <xsd:enumeration value="FOR_INTERNAL_USE_10"/>
    <xsd:enumeration value="FOR_INTERNAL_USE_11"/>
    <xsd:enumeration value="FOR_INTERNAL_USE_12"/>
    <xsd:enumeration value="FOR_INTERNAL_USE_13"/>
    <xsd:enumeration value="FOR_INTERNAL_USE_14"/>
    <xsd:enumeration value="FOR_INTERNAL_USE_15"/>
    <xsd:enumeration value="FOR_INTERNAL_USE_16"/>
    <xsd:enumeration value="FOR_INTERNAL_USE_17"/>
    <xsd:enumeration value="FOR_INTERNAL_USE_18"/>
    <xsd:enumeration value="FOR_INTERNAL_USE_19"/>
    <xsd:enumeration value="FOR_INTERNAL_USE_20"/>
    <xsd:enumeration value="HIN_CANADIAN_HEALTHCARE_IDENTIFICATION_NUMBER"/>
    <xsd:enumeration value="SCAC"/>
    <xsd:enumeration value="SELLER_ASSIGNED_IDENTIFIER_FOR_A_PARTY"/>
    <xsd:enumeration value="TD_LINK_TRADE_DIMENSIONS"/>
    <xsd:enumeration value="UCC_COMMUNICATION_IDENTIFICATION"/>
    <xsd:enumeration value="UN_LOCATION_CODE"/>
    <xsd:enumeration value="USDA_ESTABLISHMENT_NUMBER"/>
  </xsd:restriction>
</xsd:simpleType>

```

simpleType eanucc:ResponseStatusListType

```

namespace urn:ean.ucc:2
type restriction of xsd:string
used by attribute eanucc:ResponseType/@responseStatus
facets
  enumeration ACCEPTED
  enumeration MODIFIED
  enumeration REJECTED
source <xsd:simpleType name="ResponseStatusListType">
  <xsd:restriction base="xsd:string">
    <xsd:enumeration value="ACCEPTED"/>
    <xsd:enumeration value="MODIFIED"/>
    <xsd:enumeration value="REJECTED"/>
  </xsd:restriction>
</xsd:simpleType>

```

simpleType eanucc:DocumentStatusListType

```

namespace urn:ean.ucc:2
type restriction of xsd:string
used by attribute eanucc:DocumentType/@documentStatus
facets
  enumeration COPY
  enumeration ORIGINAL
  enumeration REPLACE

```

```

source <xsd:simpleType name="DocumentStatusListType">
  <xsd:restriction base="xsd:string">
    <xsd:enumeration value="COPY"/>
    <xsd:enumeration value="ORIGINAL"/>
    <xsd:enumeration value="REPLACE"/>
  </xsd:restriction>
</xsd:simpleType>

```

complexType **deliver:PackageDimensionType**

diagram

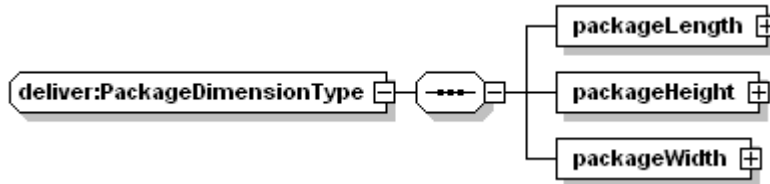

namespace urn:ean.ucc:deliver:2

children [packageLength](#) [packageHeight](#) [packageWidth](#)

used by element [deliver:LogisticUnitMeasurementType/packageDimension](#)

```

source <xsd:complexType name="PackageDimensionType">
  <xsd:sequence>
    <xsd:element name="packageLength" type="eanucc:MultiMeasurementValueType"/>
    <xsd:element name="packageHeight" type="eanucc:MultiMeasurementValueType"/>
    <xsd:element name="packageWidth" type="eanucc:MultiMeasurementValueType"/>
  </xsd:sequence>
</xsd:complexType>

```

element **deliver:PackageDimensionType/packageLength**

diagram

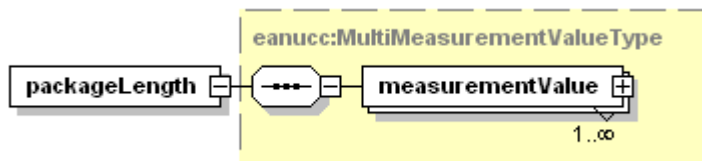

type [eanucc:MultiMeasurementValueType](#)

children [measurementValue](#)

source <xsd:element name="packageLength" type="eanucc:MultiMeasurementValueType"/>

element **deliver:PackageDimensionType/packageHeight**

diagram

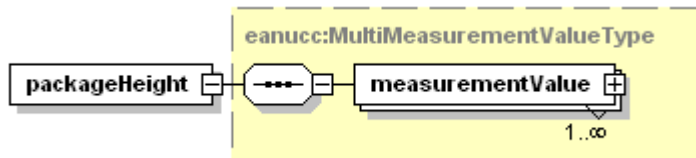

type [eanucc:MultiMeasurementValueType](#)

children [measurementValue](#)

source <xsd:element name="packageHeight" type="eanucc:MultiMeasurementValueType"/>

element **deliver:PackageDimensionType/packageWidth**

diagram

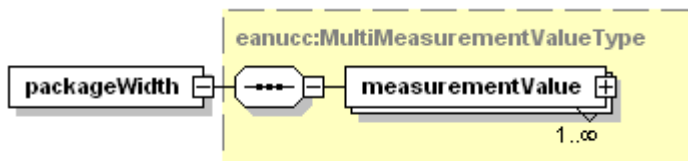

type [eanucc:MultiMeasurementValueType](#)

children [measurementValue](#)

source `<xsd:element name="packageWidth" type="eanucc:MultiMeasurementValueType"/>`

complexType **eanucc:AdditionalLogisticUnitIdentificationType**

diagram

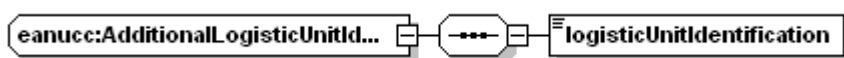

namespace `urn:ean.ucc:2`

children [logisticUnitIdentification](#)

used by element [eanucc:LogisticUnitIdentificationType/additionalLogisticUnitIdentification](#)

source `<xsd:complexType name="AdditionalLogisticUnitIdentificationType">
<xsd:sequence>
<xsd:element name="logisticUnitIdentification" type="xsd:string"/>
</xsd:sequence>
</xsd:complexType>`

element **eanucc:AdditionalLogisticUnitIdentificationType/logisticUnitIdentification**

diagram



type `xsd:string`

source `<xsd:element name="logisticUnitIdentification" type="xsd:string"/>`

complexType **eanucc:SSCCType**

diagram



namespace `urn:ean.ucc:2`

children [serialShippingContainerCode](#)

used by element [eanucc:LogisticUnitIdentificationType/serialShipmentContainerCode](#)

source `<xsd:complexType name="SSCCType">
<xsd:sequence>
<xsd:element name="serialShippingContainerCode">
<xsd:simpleType>
<xsd:restriction base="xsd:string">
<xsd:pattern value="\d{18}"/>
</xsd:restriction>
</xsd:simpleType>
</xsd:element>
</xsd:sequence>
</xsd:complexType>`

element **eanucc:SSCCType/serialShippingContainerCode**

diagram

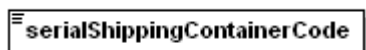

type restriction of **xsd:string**

facets pattern `\d{18}`

```
<xsd:element name="serialShippingContainerCode">
  <xsd:simpleType>
    <xsd:restriction base="xsd:string">
      <xsd:pattern value="\d{18}"/>
    </xsd:restriction>
  </xsd:simpleType>
</xsd:element>
```

complexType **eanucc:ISO3166_1CodeType**

diagram

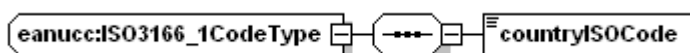

namespace urn:ean.ucc:2

children [countryISOCode](#)

used by element [eanucc:TransactionalltemDataType/countryOfOrigin](#)

```
<xsd:complexType name="ISO3166_1CodeType">
  <xsd:sequence>
    <xsd:element name="countryISOCode">
      <xsd:simpleType>
        <xsd:restriction base="xsd:string">
          <xsd:maxLength value="3"/>
          <xsd:minLength value="1"/>
        </xsd:restriction>
      </xsd:simpleType>
    </xsd:element>
  </xsd:sequence>
</xsd:complexType>
```

element **eanucc:ISO3166_1CodeType/countryISOCode**

diagram

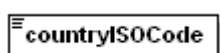

type restriction of **xsd:string**

facets minLength 1
maxLength 3

```
<xsd:element name="countryISOCode">
  <xsd:simpleType>
    <xsd:restriction base="xsd:string">
      <xsd:maxLength value="3"/>
      <xsd:minLength value="1"/>
    </xsd:restriction>
  </xsd:simpleType>
</xsd:element>
```

complexType **eanucc:ISO3166_2CodeType**

diagram



namespace urn:ean.ucc:2

children [countrySubDivisionISOCode](#)

```
<xsd:complexType name="ISO3166_2CodeType">
  <xsd:sequence>
```

```

<xsd:element name="countrySubDivisionISOCode">
  <xsd:simpleType>
    <xsd:restriction base="xsd:string">
      <xsd:maxLength value="7"/>
      <xsd:minLength value="1"/>
    </xsd:restriction>
  </xsd:simpleType>
</xsd:element>
</xsd:sequence>
</xsd:complexType>

```

element eanucc:ISO3166_2CodeType/countrySubDivisionISOCode

diagram



type restriction of **xsd:string**

facets
 minLength 1
 maxLength 7

```

source <xsd:element name="countrySubDivisionISOCode">
  <xsd:simpleType>
    <xsd:restriction base="xsd:string">
      <xsd:maxLength value="7"/>
      <xsd:minLength value="1"/>
    </xsd:restriction>
  </xsd:simpleType>
</xsd:element>

```

complexType eanucc:DocumentLineReferenceType

diagram



namespace urn:ean.ucc:2

type extension of [eanucc:LinItem](#)

children [documentReference](#)

used by element [eanucc:DocumentOrDocumentLineReferenceType/documentLineReference](#)

attributes	Name	Type	Use	Default	Fixed	Annotation
	number	xsd:nonNegative Integer	required			

```

source <xsd:complexType name="DocumentLineReferenceType">
  <xsd:complexContent>
    <xsd:extension base="eanucc:LinItem">
      <xsd:sequence>
        <xsd:element name="documentReference" type="eanucc:DocumentReferenceType" minOccurs="0"/>
      </xsd:sequence>
    </xsd:extension>
  </xsd:complexContent>
</xsd:complexType>

```

element eanucc:DocumentLineReferenceType/documentReference

diagram

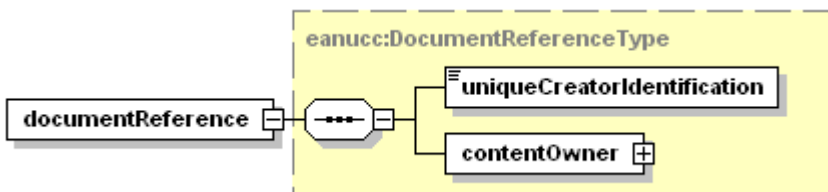

type [eanucc:DocumentReferenceType](#)

children [uniqueCreatorIdentification](#) [contentOwner](#)

attributes	Name	Type	Use	Default	Fixed	Annotation
	creationDateTim	xsd:dateTime				

source <xsd:element name="documentReference" type="eanucc:DocumentReferenceType" minOccurs="0"/>

5. Bundesbank XML-Schemas

Schema `StandardBusinessDocumentHeader.xsd`

element `StandardBusinessDocument`

diagram

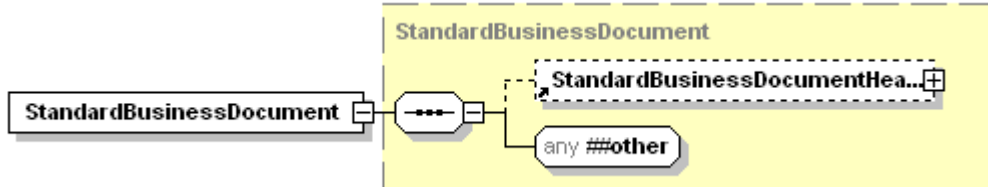

namespace `urn:csh:SDBH`

type [StandardBusinessDocument](#)

children [StandardBusinessDocumentHeader](#)

source `<xs:element name="StandardBusinessDocument" type="StandardBusinessDocument"/>`

element `StandardBusinessDocumentHeader`

diagram

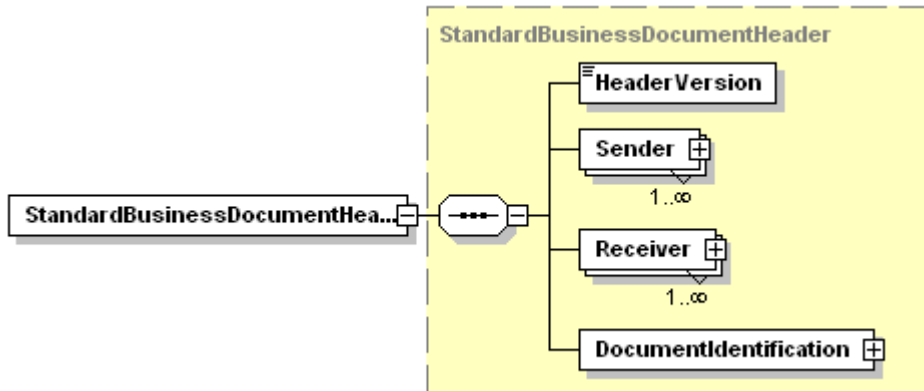

namespace `urn:csh:SDBH`

type [StandardBusinessDocumentHeader](#)

children [HeaderVersion](#) [Sender](#) [Receiver](#) [DocumentIdentification](#)

used by complexType [StandardBusinessDocument](#)

source `<xs:element name="StandardBusinessDocumentHeader" type="StandardBusinessDocumentHeader"/>`

complexType `StandardBusinessDocument`

diagram

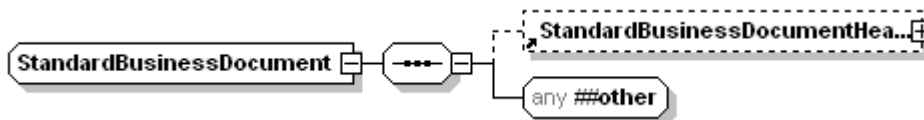

namespace `urn:csh:SDBH`

children [StandardBusinessDocumentHeader](#)

used by element [StandardBusinessDocument](#)

source `<xs:complexType name="StandardBusinessDocument">
 <xs:sequence>
 <xs:element ref="StandardBusinessDocumentHeader" minOccurs="0"/>
 <xs:any namespace="##other" processContents="lax"/>
 </xs:sequence>
 </xs:complexType>`

```

</xs:sequence>
</xs:complexType>

```

complexType **StandardBusinessDocumentHeader**

diagram

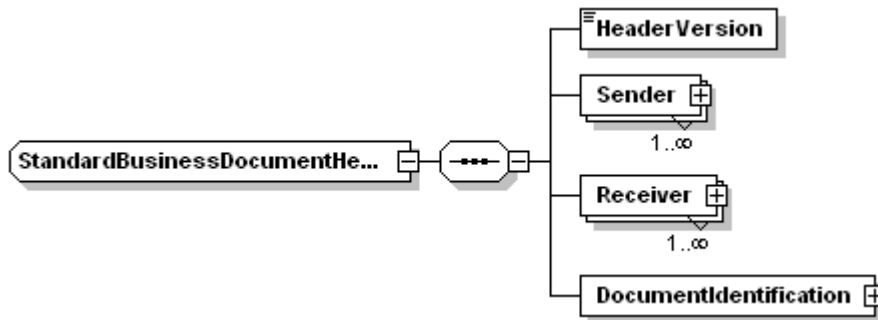

namespace urn:csh:SDBH

children [HeaderVersion](#) [Sender](#) [Receiver](#) [DocumentIdentification](#)

used by element [StandardBusinessDocumentHeader](#)

```

source <xs:complexType name="StandardBusinessDocumentHeader">
  <xs:sequence>
    <xs:element name="HeaderVersion" type="xs:string"/>
    <xs:element name="Sender" type="Partner" maxOccurs="unbounded"/>
    <xs:element name="Receiver" type="Partner" maxOccurs="unbounded"/>
    <xs:element name="DocumentIdentification" type="DocumentIdentification"/>
  </xs:sequence>
</xs:complexType>

```

element **StandardBusinessDocumentHeader/HeaderVersion**

diagram

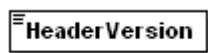

namespace urn:csh:SDBH

type **xs:string**

```

source <xs:element name="HeaderVersion" type="xs:string"/>

```

element **StandardBusinessDocumentHeader/Sender**

diagram

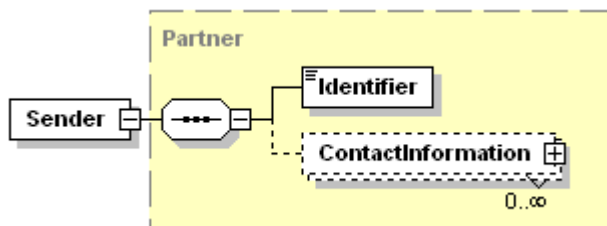

namespace urn:csh:SDBH

type [Partner](#)

children [Identifier](#) [ContactInformation](#)

```

source <xs:element name="Sender" type="Partner" maxOccurs="unbounded"/>

```

element **StandardBusinessDocumentHeader/Receiver**

diagram

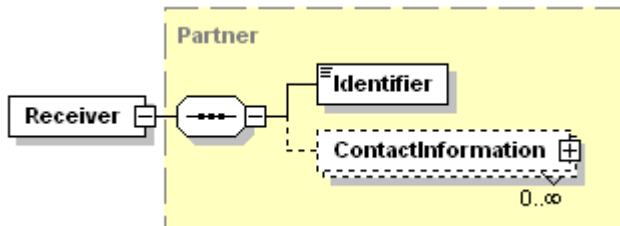

namespace urn:csh:SDBH

type [Partner](#)

children [Identifier](#) [ContactInformation](#)

source `<xs:element name="Receiver" type="Partner" maxOccurs="unbounded"/>`

element **StandardBusinessDocumentHeader/DocumentIdentification**

diagram

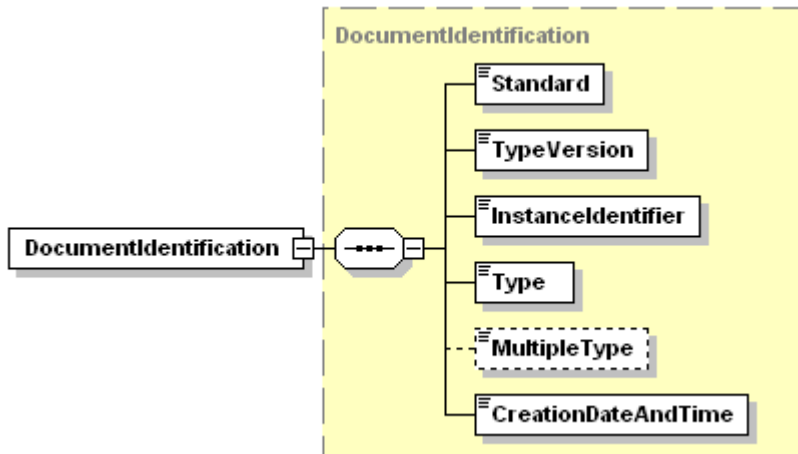

namespace urn:csh:SDBH

type [DocumentIdentification](#)

children [Standard](#) [TypeVersion](#) [InstanceIdentifier](#) [Type](#) [MultipleType](#) [CreationDateAndTime](#)

source `<xs:element name="DocumentIdentification" type="DocumentIdentification"/>`

complexType **DocumentIdentification**

diagram

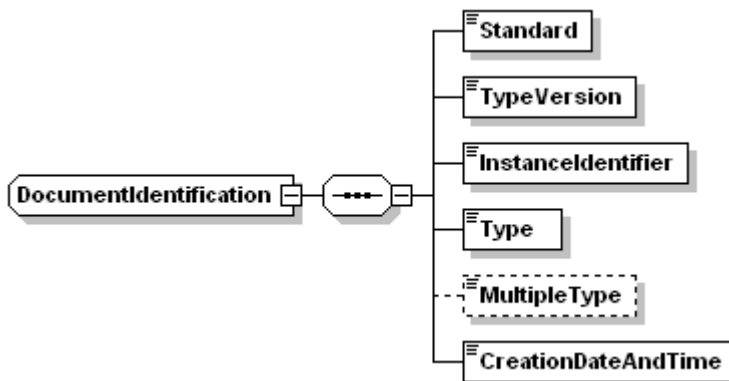

namespace urn:csh:SDBH

children [Standard](#) [TypeVersion](#) [InstanceIdentifier](#) [Type](#) [MultipleType](#) [CreationDateAndTime](#)

used by element [StandardBusinessDocumentHeader/DocumentIdentification](#)

```
<xs:complexType name="DocumentIdentification">
  <xs:sequence>
    <xs:element name="Standard" type="xs:string"/>
    <xs:element name="TypeVersion" type="xs:string"/>
    <xs:element name="InstanceIdentifier" type="xs:string"/>
    <xs:element name="Type" type="xs:string"/>
    <xs:element name="MultipleType" type="xs:boolean" minOccurs="0"/>
    <xs:element name="CreationDateAndTime" type="xs:dateTime"/>
  </xs:sequence>
</xs:complexType>
```

element **DocumentIdentification/Standard**

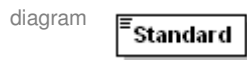

namespace urn:csh:SDBH

type **xs:string**

source `<xs:element name="Standard" type="xs:string"/>`

element **DocumentIdentification/TypeVersion**



namespace urn:csh:SDBH

type **xs:string**

source `<xs:element name="TypeVersion" type="xs:string"/>`

element **DocumentIdentification/InstanceIdentifier**



namespace urn:csh:SDBH

type **xs:string**

source `<xs:element name="InstanceIdentifier" type="xs:string"/>`

element **DocumentIdentification/Type**



namespace urn:csh:SDBH

type **xs:string**

source `<xs:element name="Type" type="xs:string"/>`

element **DocumentIdentification/MultipleType**



namespace urn:csh:SDBH

type **xs:boolean**

source `<xs:element name="MultipleType" type="xs:boolean" minOccurs="0"/>`

element DocumentIdentification/CreationDateAndTime



namespace urn:csh:SDBH

type **xs:dateTime**

source `<xs:element name="CreationDateAndTime" type="xs:dateTime"/>`

complexType ContactInformation

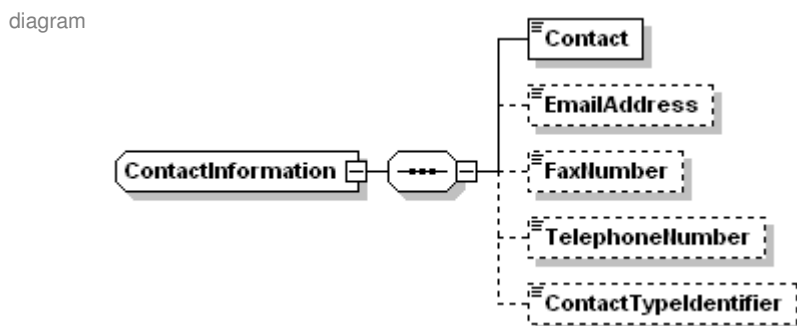

namespace urn:csh:SDBH

children [Contact](#) [EmailAddress](#) [FaxNumber](#) [TelephoneNumber](#) [ContactTypeIdentifier](#)

used by element [Partner/ContactInformation](#)

source

```
<xs:complexType name="ContactInformation">
  <xs:sequence>
    <xs:element name="Contact" type="xs:string"/>
    <xs:element name="EmailAddress" type="xs:string" minOccurs="0"/>
    <xs:element name="FaxNumber" type="xs:string" minOccurs="0"/>
    <xs:element name="TelephoneNumber" type="xs:string" minOccurs="0"/>
    <xs:element name="ContactTypeIdentifier" type="xs:string" minOccurs="0"/>
  </xs:sequence>
</xs:complexType>
```

element ContactInformation/Contact

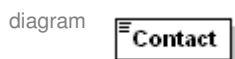

namespace urn:csh:SDBH

type **xs:string**

source `<xs:element name="Contact" type="xs:string"/>`

element ContactInformation/EmailAddress



namespace urn:csh:SDBH

type **xs:string**

source `<xs:element name="EmailAddress" type="xs:string" minOccurs="0"/>`

element **ContactInformation/FaxNumber**



namespace urn:csh:SDBH

type **xs:string**

source `<xs:element name="FaxNumber" type="xs:string" minOccurs="0"/>`

element **ContactInformation/TelephoneNumber**



namespace urn:csh:SDBH

type **xs:string**

source `<xs:element name="TelephoneNumber" type="xs:string" minOccurs="0"/>`

element **ContactInformation/ContactTypeIdentifier**



namespace urn:csh:SDBH

type **xs:string**

source `<xs:element name="ContactTypeIdentifier" type="xs:string" minOccurs="0"/>`

complexType **Partner**

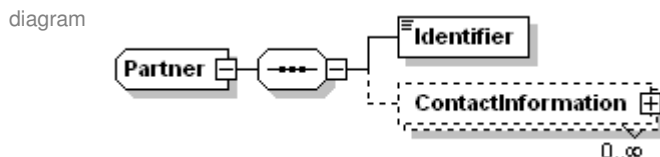

namespace urn:csh:SDBH

children [Identifier](#) [ContactInformation](#)

used by elements [StandardBusinessDocumentHeader/Receiver](#) [StandardBusinessDocumentHeader/Sender](#)

source `<xs:complexType name="Partner">
<xs:sequence>
<xs:element name="Identifier" type="PartnerIdentification"/>
<xs:element name="ContactInformation" type="ContactInformation" minOccurs="0" maxOccurs="unbounded"/>
</xs:sequence>
</xs:complexType>`

element **Partner/Identifier**



namespace urn:csh:SDBH

type [PartnerIdentification](#)

attributes	Name	Type	Use	Default	Fixed	Annotation
	Authority	xs:string				

source `<xs:element name="Identifier" type="PartnerIdentification"/>`

element **Partner/ContactInformation**

diagram

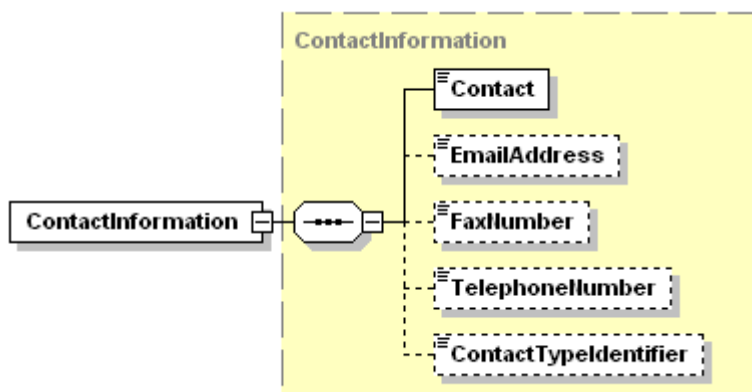

namespace urn:csh:SDBH

type [ContactInformation](#)

children [Contact](#) [EmailAddress](#) [FaxNumber](#) [TelephoneNumber](#) [ContactTypeIdentifier](#)

source `<xs:element name="ContactInformation" type="ContactInformation" minOccurs="0" maxOccurs="unbounded"/>`

complexType **PartnerIdentification**

diagram

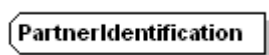

namespace urn:csh:SDBH

type extension of **xs:string**

used by element [Partner/Identifier](#)

attributes	Name	Type	Use	Default	Fixed	Annotation
	Authority	xs:string				

source `<xs:complexType name="PartnerIdentification">
 <xs:simpleContent>
 <xs:extension base="xs:string">
 <xs:attribute name="Authority" type="xs:string"/>
 </xs:extension>
 </xs:simpleContent>
 </xs:complexType>`

6. Instance File

```
<?xml version="1.0" encoding="UTF-8"?>
<csh:StandardBusinessDocument xmlns:csh="urn:csh:SBDH" xmlns:deliver="urn:ean.ucc:deliver:2"
xmlns:eanucc="urn:ean.ucc:2" xmlns:xsi="http://www.w3.org/2001/XMLSchema-instance">
  <csh:StandardBusinessDocumentHeader>
    <csh:HeaderVersion>1.0</csh:HeaderVersion>
    <csh:Sender>
      <csh:Identifier Authority="EAN.UCC">4048888000008</csh:Identifier>
    </csh:Sender>
    <csh:Receiver>
      <csh:Identifier Authority="EAN.UCC">2891100000087</csh:Identifier>
    </csh:Receiver>
    <csh:DocumentIdentification>
      <csh:Standard>EAN.UCC</csh:Standard>
      <csh:TypeVersion>2.1.1</csh:TypeVersion>
      <csh:InstanceIdentifier>12345557</csh:InstanceIdentifier>
      <csh:Type>DespatchAdvice</csh:Type>
      <csh:CreationDateAndTime>2007-11-05T16:05:00</csh:CreationDateAndTime>
    </csh:DocumentIdentification>
  </csh:StandardBusinessDocumentHeader>
  <deliver:despatchAdvice creationDateTime="2007-11-05T16:00:00" documentStatus="ORIGINAL">
    <contentVersion>
      <versionIdentification>2.1.1</versionIdentification>
    </contentVersion>
    <documentStructureVersion>
      <versionIdentification>2.1.1</versionIdentification>
    </documentStructureVersion>
    <despatchAdviceIdentification>
      <uniqueCreatorIdentification>87441</uniqueCreatorIdentification>
      <contentOwner>
        <gln>4048888000008</gln>
      </contentOwner>
    </despatchAdviceIdentification>
    <shipTo>
      <gln>2891100000087</gln>
      <additionalPartyIdentification>
        <additionalPartyIdentificationValue>DE0320000000020051000</additionalPartyIdentificationValue>
        <additionalPartyIdentificationType>FOR_INTERNAL_USE_1</additionalPartyIdentificationType>
      </additionalPartyIdentification>
    </shipTo>
    <receiver>
      <gln>2891100000087</gln>
    </receiver>
    <pickUpLocation>
      <gln>4048888200002</gln>
    </pickUpLocation>
    <shipper>
      <gln>2891300000047</gln>
    </shipper>
    <purchaseOrder>
      <uniqueCreatorIdentification>128576</uniqueCreatorIdentification>
      <contentOwner>
        <gln>2891100000087</gln>
      </contentOwner>
    </purchaseOrder>
    <purchaseConditions>
      <uniqueCreatorIdentification>Testbestellung</uniqueCreatorIdentification>
      <contentOwner>
        <gln>2891100000087</gln>
      </contentOwner>
    </purchaseConditions>
    <consignmentInformation>
      <packageInformation>
        <numberOfUnits>2</numberOfUnits>
      </packageInformation>
      <unitMeasurement>
        <measurementType>NET_VOLUME</measurementType>
        <measurementValue unitOfMeasure="EUR">
          <value>170000,00</value>
        </measurementValue>
      </unitMeasurement>
    </consignmentInformation>
  </deliver:despatchAdvice>
</csh:StandardBusinessDocument>
```



```

        </measurementValue>
    </unitMeasurement>
</consignmentInformation>
<despatchInformation>
    <estimatedDelivery>
        <estimatedDeliveryDateTime>2007-11-06T15:00:00</estimatedDeliveryDateTime>
    </estimatedDelivery>
</despatchInformation>
<despatchAdviceLogisticUnitLineItem>
    <logisticUnitIdentification>
        <serialShipmentContainerCode>
            <serialShippingContainerCode>34048888200000010</serialShippingContainerCode>
        </serialShipmentContainerCode>
    </logisticUnitIdentification>
    <quantityOfChildren>2</quantityOfChildren>
    <levelId>
        <levelIdentification>1</levelIdentification>
    </levelId>
    <despatchAdviceItemContainmentLineItem number="1">
        <containedItemIdentification>
            <gtin>4048888012759</gtin>
        </containedItemIdentification>
        <quantityContained>
            <value>1</value>
        </quantityContained>
    </despatchAdviceItemContainmentLineItem>
</despatchAdviceLogisticUnitLineItem>
<despatchAdviceLogisticUnitLineItem>
    <logisticUnitIdentification>
        <serialShipmentContainerCode>
            <serialShippingContainerCode>34048888430000011</serialShippingContainerCode>
        </serialShipmentContainerCode>
        <additionalLogisticUnitIdentification>
            <logisticUnitIdentification>1</logisticUnitIdentification>
        </additionalLogisticUnitIdentification>
    </logisticUnitIdentification>
    <quantityOfChildren>1</quantityOfChildren>
    <packageType>
        <packageTypeDescriptionCodeValue>BG</packageTypeDescriptionCodeValue>
    </packageType>
    <levelId>
        <levelIdentification>2</levelIdentification>
    </levelId>
    <parentLevelId>
        <levelIdentification>1</levelIdentification>
    </parentLevelId>
    <despatchAdviceItemContainmentLineItem number="2">
        <containedItemIdentification>
            <gtin>4048888006642</gtin>
            <additionalTradeItemIdentification>
                <additionalTradeItemIdentificationValue>Tour 18-K-
Süd</additionalTradeItemIdentificationValue>
                <additionalTradeItemIdentificationType>FOR_INTERNAL_USE_3</additionalTradeItemIdentificationType>
            </additionalTradeItemIdentification>
        </containedItemIdentification>
        <customer number="1">
            <reference>
                <referenceDateTime>2007-11-05T16:00:00</referenceDateTime>
                <referenceIdentification>2891100000162</referenceIdentification>
            </reference>
        </customer>
        <quantityContained>
            <value>10</value>
        </quantityContained>
    </despatchAdviceItemContainmentLineItem>
    <despatchAdviceItemContainmentLineItem number="3">
        <containedItemIdentification>
            <gtin>4048888007045</gtin>
            <additionalTradeItemIdentification>
                <additionalTradeItemIdentificationValue>Tour 18-K-
Süd</additionalTradeItemIdentificationValue>

```

```

<additionalTradeltemIdentificationType>FOR_INTERNAL_USE_3</additionalTradeltemIdentificationType>
  </additionalTradeltemIdentification>
</containedItemIdentification>
<customer number="1">
  <reference>
    <referenceDateTime>2007-11-05T16:00:00</referenceDateTime>
    <referenceIdentification>289110000162</referenceIdentification>
  </reference>
</customer>
<quantityContained>
  <value>10</value>
</quantityContained>
</despatchAdviceItemContainmentLineItem>
</despatchAdviceLogisticUnitLineItem>
<despatchAdviceLogisticUnitLineItem>
  <logisticUnitIdentification>
    <serialShipmentContainerCode>
      <serialShippingContainerCode>340488884300000028</serialShippingContainerCode>
    </serialShipmentContainerCode>
    <additionalLogisticUnitIdentification>
      <logisticUnitIdentification>2</logisticUnitIdentification>
    </additionalLogisticUnitIdentification>
  </logisticUnitIdentification>
  <quantityOfChildren>1</quantityOfChildren>
  <packageType>
    <packageTypeDescriptionCodeValue>BG</packageTypeDescriptionCodeValue>
  </packageType>
  <levelId>
    <levelIdentification>3</levelIdentification>
  </levelId>
  <parentLevelId>
    <levelIdentification>1</levelIdentification>
  </parentLevelId>
  <despatchAdviceItemContainmentLineItem number="4">
    <containedItemIdentification>
      <gtin>4056786542381</gtin>
      <additionalTradeltemIdentification>
        <additionalTradeltemIdentificationValue>Tour 18-K-
Nord</additionalTradeltemIdentificationValue>
      </additionalTradeltemIdentification>
    </containedItemIdentification>
  </despatchAdviceItemContainmentLineItem>
</despatchAdviceLogisticUnitLineItem>
</deliver:despatchAdvice>
</csh:StandardBusinessDocument>

<additionalTradeltemIdentificationType>FOR_INTERNAL_USE_3</additionalTradeltemIdentificationType>
  </additionalTradeltemIdentification>
</containedItemIdentification>
<customer number="1">
  <reference>
    <referenceDateTime>2007-11-05T16:00:00</referenceDateTime>
    <referenceIdentification>2891100000247</referenceIdentification>
  </reference>
</customer>
<quantityContained>
  <value>10</value>
</quantityContained>
</despatchAdviceItemContainmentLineItem>
</despatchAdviceLogisticUnitLineItem>
</deliver:despatchAdvice>
</csh:StandardBusinessDocument>

```